

**GerVetUSA™**  
Animal Care at the Highest Quality

A Division of



If we don't have the instrument  
you are looking for  
we will MANUFACTURE it for you.

# VETERINARY SURGICAL INSTRUMENT GUIDE

Small Animal, General Surgery,  
& Orthopedic Instruments

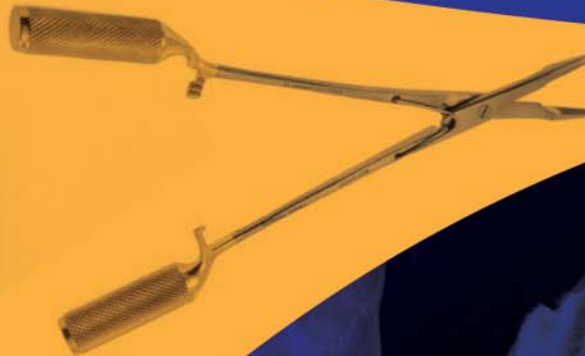
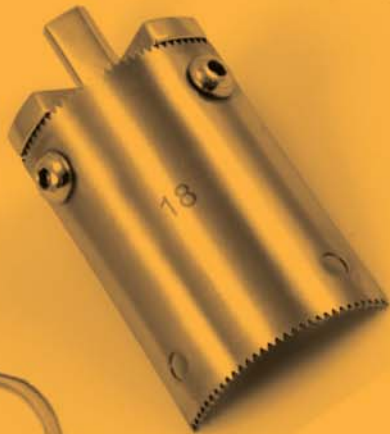

2417 JERICHO TURNPIKE, #333, GARDEN CITY PARK, NY 11040 (USA) | [www.GerVetUSA.com](http://www.GerVetUSA.com)  
TEL: 800.330.1322 | 516.358.2180 FAX: 800.260.7177 | 516.358.2182 EMAIL: [sales@GerMedUSA.com](mailto:sales@GerMedUSA.com)



All **GerMedUSA** surgical instruments are guaranteed for life against manufacturing defects, provided that the instrument is used for its intended surgical purpose. **GerMedUSA** will either repair or replace the instrument without charge at our discretion\*. Our liability under this guarantee shall be limited to repair or replacement of defective merchandise. Our guarantee is unqualified because our own quality control inspectors check **GerMedUSA** surgical instruments.

- \* Our instruments are carefully examined by our surgical instrument experts.
- \* No instrument is shipped unless it meets our standards.
- \* Tungsten carbide instruments are included except for jaw inserts and Gold handles by a separate warranty.

GerMedUSA not only offers Veterinarians quality products but also services that meet the demands of today's growing veterinarian practice. Offering a complete line of specialty, general and premium instruments that complement the routine to dental and surgical procedures

© [www.GerVetUSA.com](http://www.GerVetUSA.com)  
2005-2012. All Rights Reserved.  
1188 Willis Avenue #801 Albertson,  
NY 11507  
TT: 888-814-4650 / 516-385-3434  
F: 888-600-0310 / 516-358-2182  
eMAIL: [sales@gervetusa.com](mailto:sales@gervetusa.com)

## Atraumatic Forceps



G47-118  
Cooley Vascular Tissue Forceps,  
tips 2mm wide, 6"

G47-120  
Cooley Vascular Tissue Forceps,  
tips 2mm wide, 8"



G47-100  
Debaquey Thoracic Tissue Forceps,  
2.5mm wide Tips, 6"



G47-117  
Debaquey Tissue Forceps,  
Atraumatic Jaws, 2.0mm, 7.75"

G47-119  
Debaquey Tissue Forceps,  
Atraumatic Jaws, 2.0mm, 9.5"

G47-121  
Debaquey Tissue Forceps,  
Atraumatic Jaws, 3.5mm, 6.25"

G47-123  
Debaquey Tissue Forceps,  
Atraumatic Jaws, 3.5mm, 7.75"

G47-115  
Debaquey Tissue Forceps,  
Atraumatic Jaws, 2.0mm, 6.25"

G47-125  
Debaquey Tissue Forceps,  
Atraumatic Jaws, 3.5mm, 9 1/2"



G47-116  
Debaquey Adson Tissue Forceps,  
4 3/4", 1.5 mm tips

## Atraumatic Forceps



G47-188  
Debakey Vascular Clamp for Aortic Aneurysm, slightly curved jaws 7.5 cm, Size 10".

G47-190  
Debakey Vascular Clamp for Aortic Aneurysm, slightly curved jaws 8.5 cm, Size 10 1/2".

G47-192  
Debakey Vascular Clamp for Aortic Aneurysm, slightly curved jaws 10 cm, Size 12 1/4".

G47-194  
Debakey Vascular Clamp for Aortic Aneurysm, slightly curved jaws 12 cm, Size 12 3/4".

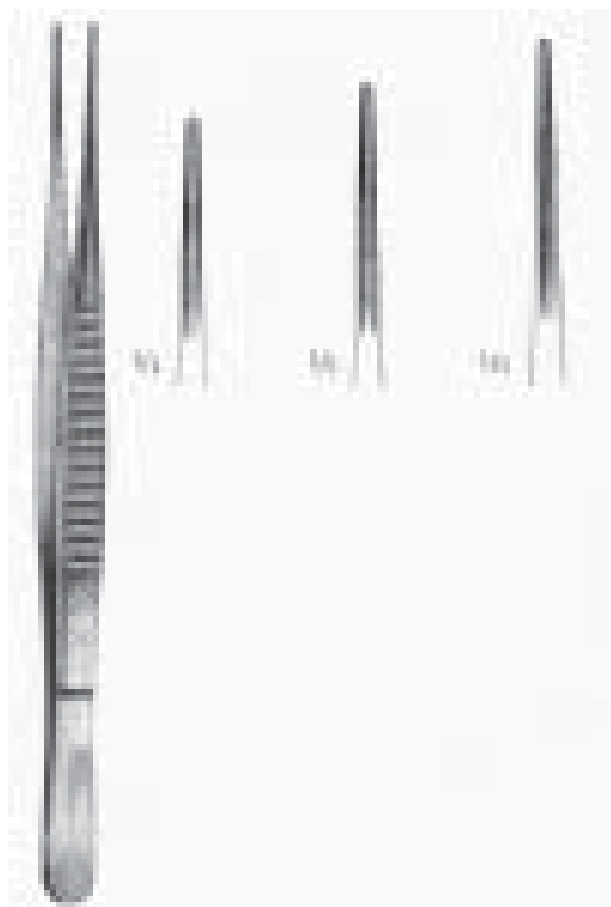

G47-108  
Debakey Vascular Tissue Forceps, 1.5mm wide Tips, 6"

G47-112  
Debakey Vascular Tissue Forceps, 1.5mm wide Tips, 8"

G47-114  
Debakey Vascular Tissue Forceps, 1.5mm wide Tips, 9 1/2"



GD50-123  
Heidbrink Root Tip Pick, Del H1,  
Delicate, Straight, 5 1/4"

GD50-126  
Heidbrink Root Tip Pick, Del H2-  
3, Delicate, Double Ended, 7 3/4"



GD50-125  
Heidbrink Root Tip Pick, Del  
H3, Delicate, Left, 5 1/4"



GD50-124  
Heidbrink Root Tip Pick, Del H3,  
Delicate, Right, 5 1/4"

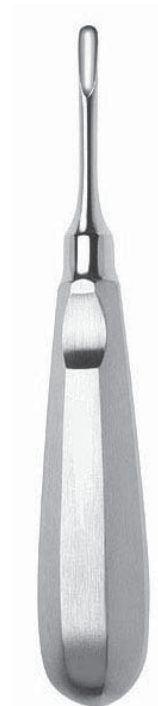

GD50-113  
Root Elevator, Crane Pick, DEL  
34

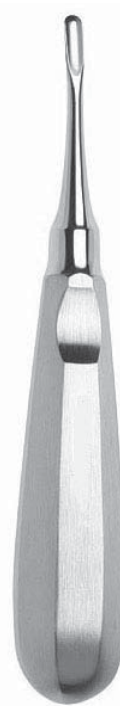

GD50-114  
Root Elevator, Crane Pick, DEL  
34S

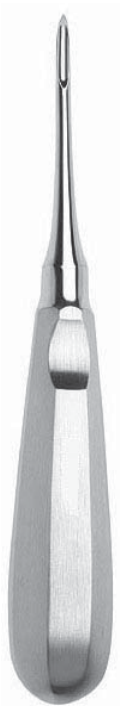

GD50-115  
Root Elevator, Crane Pick,  
DEL46 Elevator



GD50-10-3  
Root Elevators, Apical, DEL 301

# Dental Elevators



GD50-101  
Root Elevators, Apical, DEL  
302HF



GD50-102  
Apical Del 303 Elevator, 5 3/4"



GD50-120  
Root Elevators, DEL 78

GD50-627  
Root Tip Elevator, Del 79,  
Curved Right, 5 1/2"  
GD50-629  
Root Tip Elevator, Del 80,  
Curved Left, 5 1/2"

## Dental Elevators



GD50-501  
Winged Tip Elevator with  
removeable handle, 2mm, 4  
3/4"

GD50-502  
Winged Tip Elevator with  
removeable handle, 3mm, 4  
3/4"

GD50-503  
Winged Tip Elevator with  
removeable handle, 4mm, 4  
3/4"

GD50-504  
Winged Tip Elevator with  
removeable handle, 5mm,  
4 3/4"

GD50-505  
Winged Tip Elevator with  
removeable handle, 6mm, 4  
3/4"

GD50-506  
Winged Tip Elevator with  
removeable handle, 7mm,  
4 3/4"

GD50-507  
Winged Tip Elevator with  
removeable handle, 8mm,  
4 3/4"



G40-09  
Luxating Elevator, Curved Tip  
2mm, 5 3/4"

G40-13  
Luxating Elevator, Straight Tip  
2mm, 5 3/4"

G40-10  
Luxating Elevator, Curved Tip  
3mm, 5 3/4"

G40-14  
Luxating Elevator, Straight Tip  
3mm, 5 3/4"

G40-11  
Luxating Elevator, Curved Tip  
4mm, 5 3/4"

G40-15  
Luxating Elevator, Straight Tip  
4mm, 5 3/4"

G40-12  
Luxating Elevator, Curved Tip  
5mm, 5 3/4"

G40-16  
Luxating Elevator, Straight Tip  
5mm, 5 3/4"

# Dental Extracting Forceps

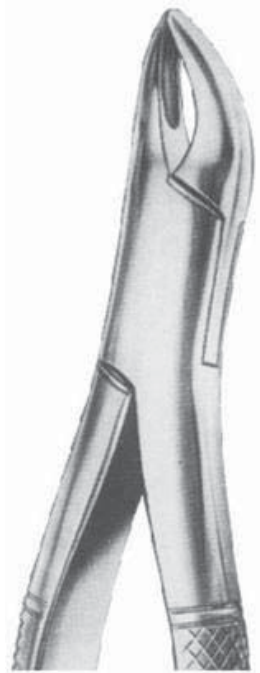

GD50-1218  
Dental Extracting Forceps  
Universal, Witzel, DEF116



GD50-1219  
Dental Extracting Forceps  
Universal, Witzel, DEF120

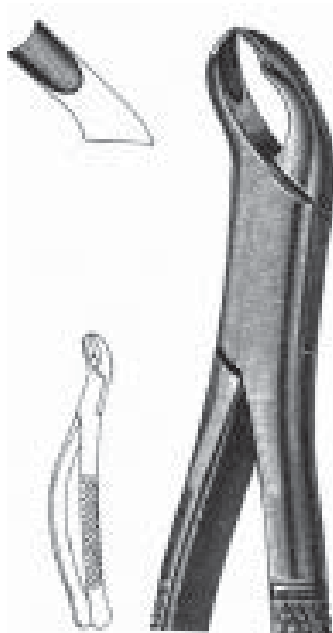

GD50-12  
Dental Extracting Forceps, 1st  
and 2nd Molar, Left, 18L



GD50-70  
Dental Extracting Forceps, A,  
Pedo Upper Molar, Universal, Mini



GD50-51  
Standard Extracting Forceps #1



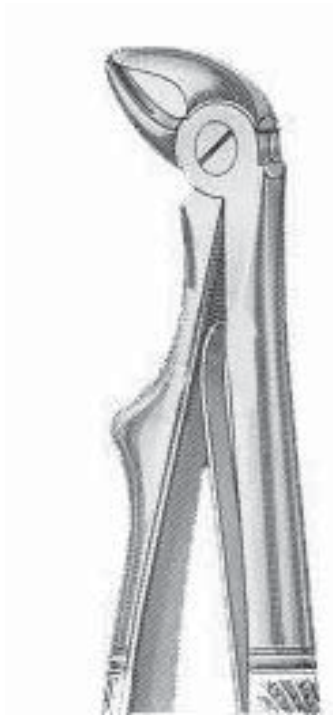

GD50-71  
Dental Extracting Forceps, B,  
Pedo Lower Root, Universal, Mini



GD50-73  
Dental Extracting Forceps, E,  
Pedo Upper Front, Mini

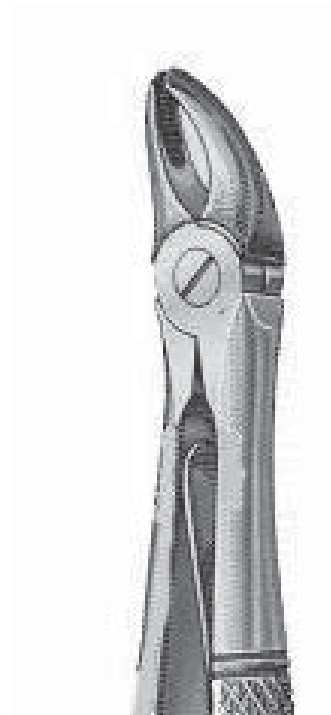

GD50-74  
Dental Extracting Forceps, F,  
Pedo Upper Root, Universal, Mini



GD50-41  
Dental Extracting Forceps,  
Lower Incisors, Cuspids, and Bi-  
cuspids and Roots, Universal, 151



GD50-47  
Dental Extracting Forceps,  
Upper and Lower Bicuspids and  
Deciduous, Universal, 101



GD50-49  
Dental Extracting Forceps,  
Upper and Lower Fragments and  
Roots, 69

# Dental Extracting Forceps



GD50-48  
Dental Extracting Forceps,  
Upper and Lower Splitting  
and Separating, 6

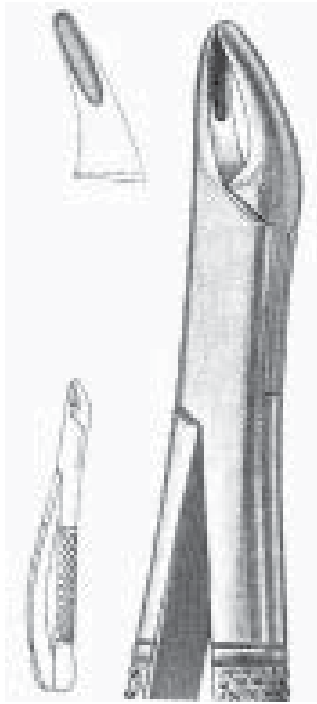

GD50-39  
Dental Extracting Forceps,  
Upper Anteriors, Split Beaks,  
Serrated, 150AS

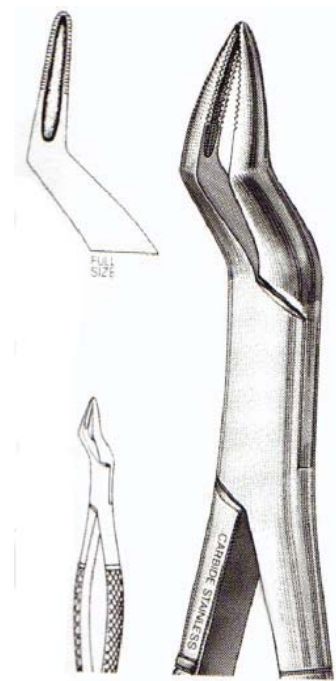

GD50-40  
Dental Extracting Forceps,  
Upper Bicuspids, Incisors and  
Roots, 286



GD50-37  
Dental Extracting Forceps,  
Upper Incisors, Cuspids and  
Bicuspids and Roots, Universal,  
150



GD50-34  
Dental Extracting Forceps,  
Upper Incisors, Henahan, 1HEN

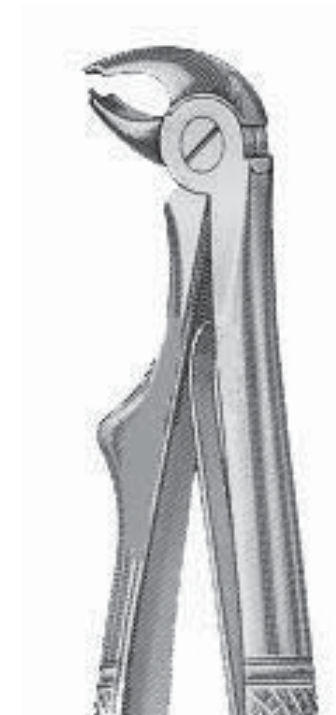

GD50-72  
Dental Extracting Forceps, C,  
Pedo Lower Molars, Universal,  
Mini

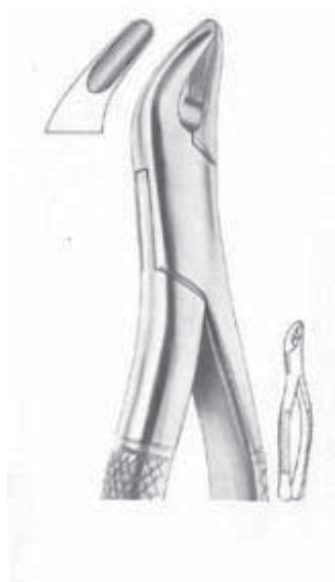

GD50-46  
Dental Standard Extracting  
Forceps #62



GD50-61  
Universal Extracting Forceps  
175



GD50-66  
Universal Extracting Forceps,  
150S



GD50-67  
Universal Extracting Forceps,  
151S

Dental Explorers



GD50-301  
Dental Explorer 2D



GD50-301-1  
Dental Explorer and Graduated  
Probe, D/E style PE1-23

# Dental Explorer



GD50-303  
Dental Explorer, 17



GD50-300  
Dental Explorer, Style 7



GD50-304  
Dental Explorer, style 3A



GD50-133  
Elevator, Periosteal, Molt, DEL  
M9



GD50-1523  
Excavator Style #33L



GD50-1520  
Excavator Style #38/39

## Dental Explorer



GD50-1521  
Excavator Style #61/62



GD50-735  
Probe 20-23 Explorer TT DE

## Dental Rongeur

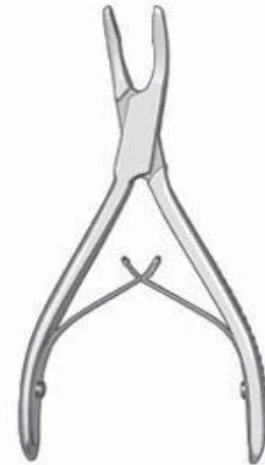

GD50-150  
Friedman Dental Rongeur 5 1/2",  
Curved & Delicate

## Dental Scrapers & Chisels



GD50-399  
Hirschfeld File, 5-11  
GD50-400  
Hirschfeld File, 3-7  
GD50-401  
Hirschfeld File, 9-10



GD50-1525  
Ochsenbein Chisel #1  
GD50-1526  
Ochsenbein Chisel #2



GD50-1524  
Ochsenbein Chisel 4

## Dental Scrapers & Chisels

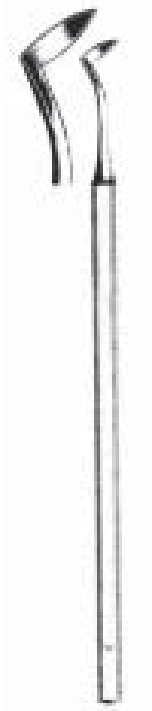

GD206-101  
Scraper, Angular Point



GD206-10  
Scraper, Curved, with Straight  
Edge



GD206-103  
Scraper, Curved, With Angled  
Edge



GD206-104  
Scraper, Double End, Curved,  
With Angled Edges



GD206-102  
Scraper, Triangle

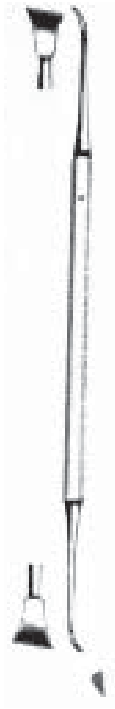

GD206-09  
Tartar Scraper, Claw Type



G-206-09  
Tartar Scraper D/E, Curved,  
Angled, style #12

## Dental Scissors



G18-280  
Vannas After-Cataract Scissors,  
3 1/8", Straight

G18-282  
Vannas Scissors, Angled on Flat,  
3"

## Dental Mouth Gags

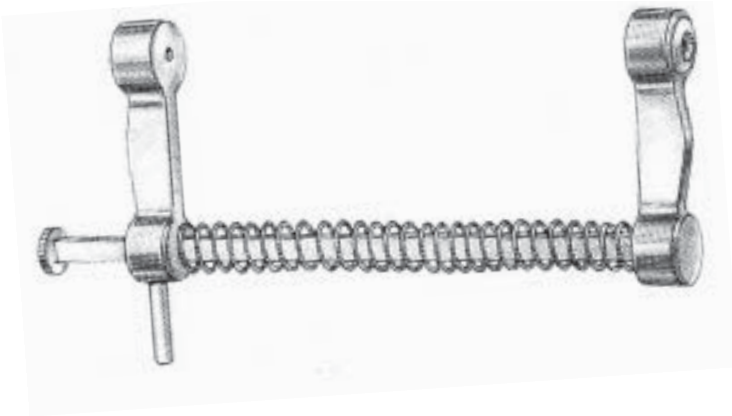

G90-900  
Canine Mouth Gag Small Size 4"

G90-905  
Canine Mouth Gag Medium Size 5  
3/4"

G90-910  
Canine Mouth Gag Large Size 6 3/4"

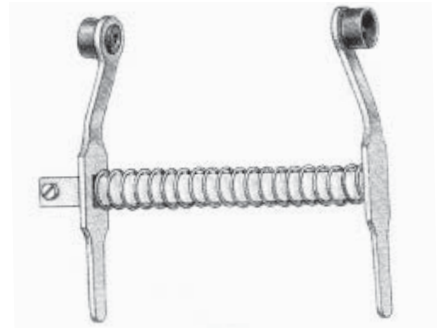

G90-890  
Feline Petite Mouth Gag  
Light Weight 2 1/4"

G90-895  
Feline Mouth Gag Light

## Dental Mirrors



GD50-593  
Mirror Handle Cone Socket/  
Mirror #4



GD50-616  
Autoclavable Front Surface  
Fiberglass Mirror, #4 and 5  
White, 10/box



## Dental Mirrors



G21-06-0  
Dental Laryngeal Mirror  
Size 0, 12mm



G21-06-01  
Dental Laryngeal Mirror  
Size 1, 14mm



G21-06-02  
Dental Laryngeal Mirror  
Size 2, 16mm



G21-06-03  
Dental Laryngeal Mirror  
Size 3, 18mm



G21-06-04  
Dental Laryngeal Mirror Size 4,  
20mm



G21-06-05  
Dental Laryngeal Mirror Size  
5, 22mm



G21-06-06  
Dental Laryngeal Mirror Size 6,  
26mm

## Dental Mirrors

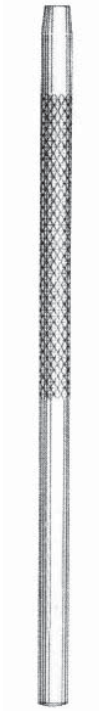

GD50-614  
Deluxe Mirror Handle Cone  
Socket

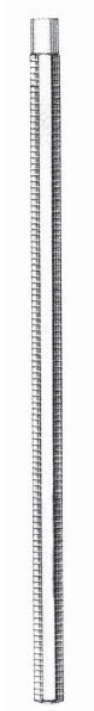

GD50-612  
Octagonal Mirror Handle,  
Cone socket

## Dental Scalers



G206-08  
Scaler, Jacquette H 6/7



GD50-789  
Jacquette Scaler, 20/33



GD50-790  
Jacquette Scaler, 33/H5



GD50-775  
Jacquette Scaler, Double Ended,  
1Y/1Y



GD50-779  
Jacquette Scaler, Double Ended, 2/3

## Dental Scalers



GD50-781  
Jacquette Scaler, Double  
Ended, 2S/3S



GD50-777  
Jacquette Scaler, Double Ended,  
2Y/3Y



GD50-774  
Jacquette Scaler, Single Ended,  
U-15

## Dental Bone Curettes



GD50-810  
Morse Scaler 0-00



GD50-203  
Lucas Bone Curette, No.87



GD50-201  
Lucas Bone Curette, No. 85

## Dental Bone Curettes



GD50-202  
Lucas Bone Curette, No. 86

## Dental Curettes



GD50-758  
Curette Columbia 13-14 Fine  
TTDE, Double Ended



GD50-757  
Curette Columbia 4L-4R TTDE,  
Double Ended



GD50-796  
Orban Knife 1-2



GD50-754  
Gracey Curettes 9/10,  
Double Ended



GD50-755  
Gracey Curettes 11/12,  
Double Ended



GD50-756  
Gracey Curettes 13/14,  
Double Ended



GD50-157  
Gracey Curettes G 1/2,  
Double Ended



GD50-751  
Gracey Curettes 3/4, Double  
Ended



GD50-752  
Gracey Curettes 5/6, Double  
Ended



GD50-813  
Gracey Curettes 11/14  
GD50-820  
Gracey Curettes 12/13

GD50-811  
Gracey Curettes 15/16  
GD50-812  
Gracey Curettes 17/18

## Dental Currettes



GD50-777-1  
Curette Style H6/7



GD50-310  
McCalls Curette, Style 17/18  
GD50-311  
McCalls Curette, Style 11/14

## Dressing & Tissue Forceps

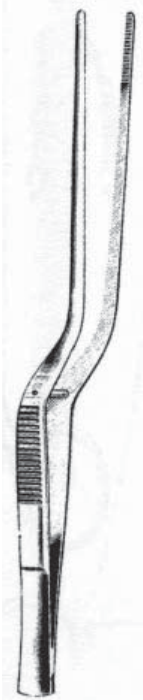

G46-290  
Adson Bayonet Dressing  
Forceps, Serrated, 8 1/4"



G12-21  
Adson Dressing Forceps 4 3/4"  
Serrated  
G12-22  
Adson Forceps 4 3/4" 1x2th



G12-21D  
Adson Dressing Forceps,  
Delicate, Serrated Jaws 4 3/4"



G12-56  
Adson Forceps 4 3/4"  
Micro With 1x2th



G12-55  
Adson Forceps 4 3/4"  
Micro With Serrations



G12-304  
Adson Tissue and Suture  
Forceps, 4 3/4", 1x2 teeth  
with tying platform.



G17-123  
Adson Tissue Forceps, 1x2  
with Carbide Suture Platform,  
4.75"



G12-302  
Adson Tissue Forceps,  
2x3 Teeth Delicate, 4 3/4"

## Dressing & Tissue Forceps



G17-56  
Adson Tissue Forceps, Cross  
Serrated Atraumatic Carbide  
Grip, 4.75"



G12-121  
Adson-Brown Forceps, 9x9  
teeth, side grasp, 4 3/4"



G12-26  
Brown-Adson Side Grasping  
Forceps, 4 3/4", 7X7th



G12-310  
Brown-Adson Tissue Forceps,  
7x7 side grasping teeth, angular,  
4 3/4"



G11-59  
Allis Adair Tissue Forceps,  
9X10 Teeth, 6"



G11-154  
Allis-Willauer Tissue Forceps,  
5X6 Teeth, 10"





G11-98  
Allis Tissue Forceps, 3X4  
Teeth, 6"

G11-20  
Allis Tissue Forceps, 4X5  
Teeth, 6"

G11-21  
Allis Tissue Forceps, 5X6  
Teeth, 6"

G11-198  
Allis Tissue Forceps 4x5th 7  
1/2"

G11-46  
Allis Tissue Forceps, 5X6  
Teeth, 7 1/2"



G11-152  
Baby Allis Tissue Forceps  
5" Extra Delicate

G11-153  
Baby Allis Tissue Forceps  
5 1/2" Delicate



G18-148  
Bishop Harmon Dressing Forceps 1 x 2th, 3  
1/4"

G18-150  
Bishop Harmon Dressing Forceps 3 1/4"  
1x2th, Delicate

G18-151  
Bishop Harmon Dressing Forceps, Serr, 3 3/8"



G10-507  
Beasley Babcock Tissue Forceps,  
Cross Points, 4 3/4"

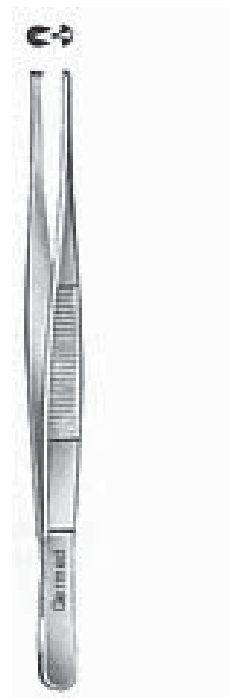

G12-15  
Bonney Tissue Forceps, 1X2  
Teeth, 7"

## Dressing & Tissue Forceps

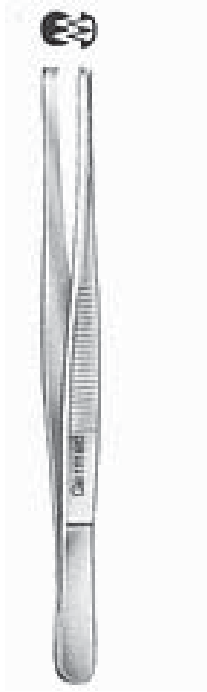

G12-14  
Bonney Tissue Forceps, 2x3  
Teeth, 7"



G12-201  
Brown Tissue Forceps, double  
rows of 8x8 teeth, Size 6"



G18-126  
Eye Dressing Forceps 4" Serr

G18-128  
Eye Dressing Forceps, 4" Heavy

G18-127  
Eye Dressing Forceps, 4" Serr,  
Straight Tips, Non-magnetic



G18-130  
Eye Dressing Forceps, 4" Half-  
Curved Tips, Heavy Pattern

G18-129  
Eye Dressing Forceps, Half  
Curved, Serrated Tips, 4"



G18-131  
Eye Dressing Forceps, Full  
Curved, Serrated Tips, 4"



G20-25  
Ferris Smith Tissue Forceps,  
2x3 Teeth, 6 3/4"



G18-144  
Iris Tissue Forceps 4" 1x2th  
Straight, Standard

G18-146  
Iris Tissue Forceps 4" 1/2 Half-  
Curved

G18-147  
Iris Tissue Forceps 4", 1x2th,  
Full Curved



G13-613  
Lahey Vulsellum Forceps,  
3X3 Teeth, 6 1/4"



G11-80  
Pedifine Allis Tissue Forceps,  
4X5 Teeth, 4 3/4"

G11-81  
Pedifine Allis Tissue Forceps,  
4X5 Teeth, 5 3/4"



G12-60  
Plain (Splinter) Forceps, 3 1/2"

G12-61  
Plain (Splinter) Forceps, 4 1/2"

## Dressing & Tissue Forceps



G12-76  
Potts-Smith Dressing Forceps,  
Serrated Jaw, 6"

G12-48  
Potts-Smith Dressing Forceps,  
Serrated Jaw, 7"

G12-49  
Potts-Smith Dressing Forceps,  
Serrated Jaw, 8 1/4"

G12-84  
Potts-Smith Dressing Forceps,  
Serrated Jaw, 9 1/2"



G12-320  
Semken Tissue Forceps, 1X2  
Teeth, Curved Tips, Size 5"

G12-325  
Semken Tissue Forceps, 2X3  
Teeth, Curved Tips, Size 5"



G12-77  
Potts-Smith Tissue Forceps,  
1X2 Teeth, 6"

G12-51  
Potts-Smith Tissue Forceps,  
1X2 Teeth, 7"

G12-52  
Potts-Smith Tissue Forceps,  
1X2 Teeth, 8 1/4"

G12-71  
Potts-Smith Tissue Forceps,  
1X2 Teeth, 9 1/2"



G18-163  
Von Graefe Fixation Forceps, Spring  
Catch, Non-magnetic, 4 3/8"

## Dressing & Tissue Forceps



G12-27  
Thumb Dressing Forceps,  
Serrated Jaws, 4 1/2"

G12-03  
Thumb Dressing Forceps,  
Serrated Jaws, 8"

G12-28  
Thumb Dressing Forceps,  
Serrated Jaws, 5"

G12-04  
Thumb Dressing Forceps 10"  
Serrated

G12-01  
Thumb Dressing Forceps,  
Serrated Jaws, 5 1/2"

G12-05  
Thumb Dressing Forceps 12"  
Serrated

G12-02  
Thumb Dressing Forceps 6"  
Serrated



G12-29  
Thumb Tissue Forceps, 1x2 Teeth,  
4 1/2"

G12-08  
Thumb Tissue Forceps, 1x2  
Teeth, 8"

G12-30  
Thumb Tissue Forceps, 1x2  
Teeth, 5"

G12-66  
Thumb Tissue Forceps, 1x2  
Teeth, 10"

G12-06  
Thumb Tissue Forceps, 1x2  
Teeth, 5 1/2"

G12-10  
Thumb Tissue Forceps, 1x2  
Teeth, 12"

G12-07  
Thumb Tissue Forceps, 1x2  
Teeth, 6"

## Dressing & Tissue Forceps



G12-96  
Thumb Tissue Forceps, 2x3 Teeth, 5"

G12-11  
Thumb Tissue Forceps, 2x3 Teeth 5 1/2"

G12-12  
Thumb Tissue Forceps, 2x3 Teeth,  
6"

G12-13  
Thumb Tissue Forceps, 2x3 Teeth,  
8"

G12-97  
Thumb Tissue Forceps, 3x4 Teeth,  
5"

G12-16  
Thumb Tissue Forceps, 3x4 Teeth,  
5 1/2"

G12-17  
Thumb Tissue Forceps, 3x4 Teeth,  
6"

## Ear Instruments



G19-179  
Bane Mastoid Rongeur, Curved,  
7"



G19-181  
Beyer-Stille Rongeur 7"4x15mm  
Bite Curved

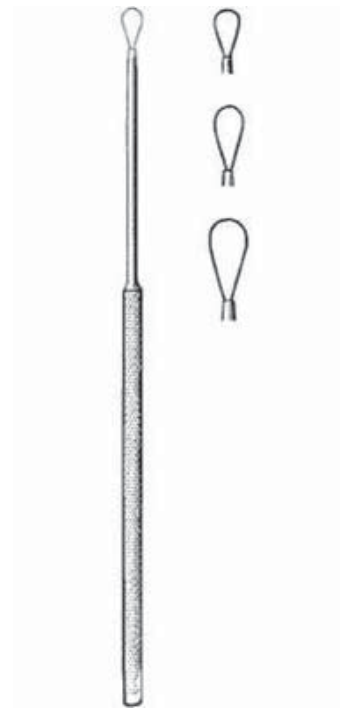

G19-19  
Billeau Ear Loops, Delicate, 6 1/2",  
small Loop

G19-18  
Billeau Ear Loops, Delicate, 6 1/2",  
medium Loop

G19-17  
Billeau Ear Loops, Delicate, 6 1/2",  
Large Loop

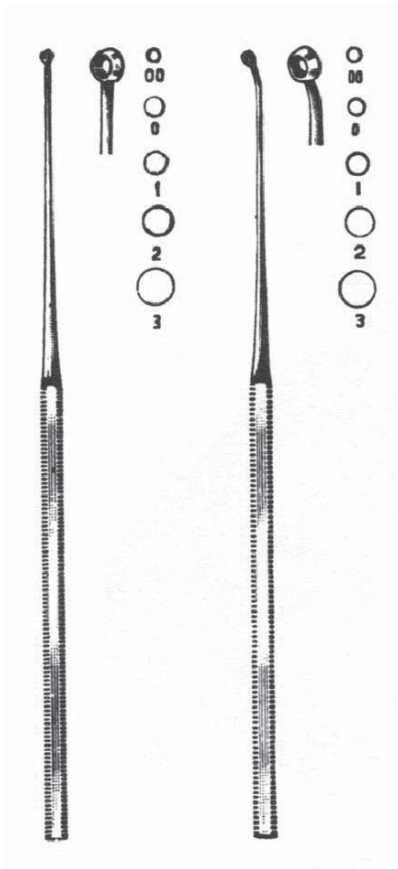

G19-26  
Buck Ear Curette, 5 1/2",  
Straight, Sharp, Size 5

G19-27  
Buck Ear Curette, 5 3/4",  
Angled Sharp, Size 00

G19-28  
Buck Ear Curette, 5 3/4",  
Angled Sharp, Size 0

G19-29  
Buck Ear Curette, 5 3/4",  
Angled Sharp, Size 1

G19-30  
Buck Ear Curette, 5 3/4",  
Angled Sharp, Size 2

G19-31  
Buck Ear Curette, 5 3/4",  
Angled Sharp, Size 3

G19-32  
Buck Ear Curette, 5 3/4",  
Angled Sharp, Size 4

G19-33  
Buck Ear Curette, 5 3/4",  
Angled Sharp, Size 5

G19-34  
Buck Ear Curette, 5 3/4",  
Straight Blunt, Size 00

G19-35  
Buck Ear Curette, 5 3/4",  
Straight Blunt, Size 0

G19-36  
Buck Ear Curette, 5 3/4",  
Straight Blunt, Size 1

G19-37  
Buck Ear Curette, 5 3/4",  
Straight Blunt, Size 2

G19-38  
Buck Ear Curette, 5 3/4",  
Straight Blunt, Size 3

G19-39  
Buck Ear Curette, 5 3/4",  
Straight Blunt, Size 4

G19-40  
Buck Ear Curette, 5 3/4",  
Straight Blunt, Size 5

G19-41  
Buck Ear Curette, 5 3/4",  
Angled Blunt, Size 00

G19-42  
Buck Ear Curette, 5 3/4",  
Angled Blunt, Size 0

G19-43  
Buck Ear Curette, 5 3/4",  
Angled Blunt, Size 1

G19-44  
Buck Ear Curette, 5 3/4",  
Angled Blunt, Size 2

G19-45  
Buck Ear Curettes, 5 3/4",  
Angled blunt, size 3

G19-46  
Buck Ear Curette, 5 3/4",  
Angled Blunt, Size 4

G19-47  
Buck Ear Curette, 5 3/4",  
Angled Blunt, Size 5

G19-20  
Buck Ear Curette, 5 1/2",  
Straight, Sharp, Size 00

G19-21  
Buck Ear Curette, 5 1/2",  
Straight, Sharp, Size 0

G19-22  
Buck Ear Curette, 5 1/2",  
Straight, Sharp, Size 1

G19-23  
Buck Ear Curette, 5 1/2",  
Straight, Sharp, Size 2

G19-24  
Buck Ear Curette, 5 1/2",  
Straight, Sharp, Size 3

G19-25  
Buck Ear Curette, 5 1/2",  
Straight, Sharp, Size 4

# Ear Instruments



G21-96  
Poole Suction Tube 23  
Fr. Curved

G21-95  
Poole Suction Tube 30  
Fr. Straight



G21-138  
Pynchon Suction Tube 10" tip  
with large removable tubing

G21-136  
Pynchon Suction Tube 11" tip  
with large removable tubing



G21-10  
Yankauer Suction Tube 11 3/4"  
with removable tip and tubing  
connection



G21-11  
Yankauer Suction Tube,  
chrome plated, replacement  
tip only



G19-107  
Baron Suction Tube, Size 3  
French, 7 1/2"

G19-108  
Baron Suction Tube, Size 5

G19-109  
Baron Suction Tube, Size 7  
French, 7 1/2"



G19-59  
Ferguson-Frazier Suction Tubes,  
10 French

G19-61  
Ferguson-Frazier Suction Tubes,  
14 French

G19-62  
Ferguson-Frazier Suction Tubes,  
12 French

G19-63  
Ferguson-Frazier Suction Tubes,  
6 French

G19-64  
Ferguson-Frazier Suction Tubes,  
7 French

G19-65  
Ferguson-Frazier Suction Tubes,  
8 French

G19-66  
Ferguson-Frazier Suction Tubes,  
11 French

G19-85  
Ferguson-Frazier Suction Tubes,  
9 French



G104-01  
Hartman Alligator Forceps  
Serrated Jaw, 3"

G104-02  
Hartman Alligator Forceps  
Serrated Jaw, 5 1/2"

G104-03  
Hartman Alligator Forceps  
Serrated Jaw, 6 1/2"

G104-04  
Hartman Alligator Forceps  
Round Cup Jaws, 2 1/2"

G104-05  
Hartman Alligator Forceps  
1 x 2 Teeth





G24-360  
Hartman Rongeur, Curved,  
4x12mm bite, Size 5 3/4"



G22-245  
Volkman Double Ended  
Curette, 5" 6 x10mm



G09-02  
Taylor Percussion Hammer 7"

G09-01  
Taylor Percussion Hammer 8"



G19-161  
Volkman Bone Curette Size 0

G19-162  
Volkman Bone Curette Size 1

G19-160  
Volkman Bone Curette Size 2/0

G19-163  
Volkman Bone Curette Size 2

G19-159  
Volkman Bone Curette Size 3/0

G19-164  
Volkman Bone Curette Size 3

G19-158  
Volkman Bone Curette Size 4/0

G19-165  
Volkman Bone Curette Size 4

G19-157  
Volkman Bone Curette Size 5/0

G19-166  
Volkman Bone Curette Size 5

G19-167  
Volkman Bone Curette Size 6

# Forceps



G11-19  
Babcock Abdominal Forceps, 6 1/4"  
G11-60  
Babcock Abdominal Forceps, 8"  
G11-45  
Babcock Abdominal Forceps, 9 1/2"



G12-44  
Carmalt (Splinter) Forceps,  
Straight, 4 3/4"  
G12-45  
Carmalt (Splinter) Forceps,  
Curved, 4 3/4"



G40-06  
Castroviejo Suturing Forceps, Curved,  
0.5mm Tip with tying platform, 4 1/4"  
G18-187  
Castroviejo Suturing Forceps,  
Straight, 0.5mm Tip with tying plat-  
form, 4 1/4"



G11-168  
Baby Doyen Intestinal Forceps  
Straight 6 1/2"  
G11-169  
Baby Doyen Intestinal Forceps  
Curved 6 1/2"



G11-174  
Doyen Intestinal Forceps Straight 9"  
G11-175  
Doyen Intestinal Forceps Curved 9"

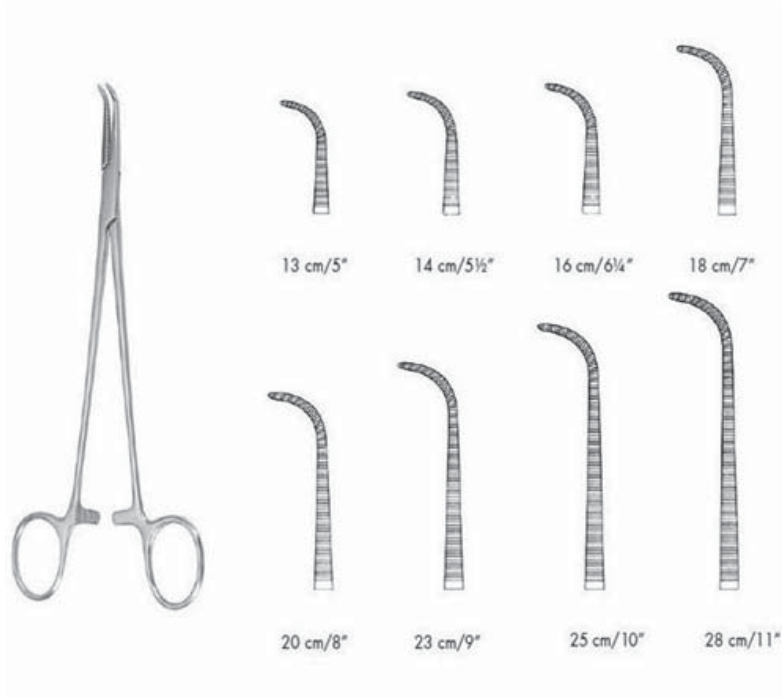

G11-114  
Gemini-Mixer, Delicate,  
Full Curved Jaws, 5 1/2"

G11-115  
Gemini-Mixer, Delicate,  
Full Curved Jaws, 7"

G11-116  
Gemini-Mixer, Delicate,  
Full Curved Jaws, 8"

G11-117  
Gemini-Mixer, Delicate,  
Full Curved Jaws, 9"

Grooming Instruments



G22-295  
Tissue & Cuticle Nipper 4",  
Convex Jaws

G22-296  
Tissue and Cuticle Nipper,  
Convex Jaws, 4 1/2"



G22-297  
Tissue & Cuticle Nipper 4",  
Convex Jaws



G1009-01  
White Toe Nail Scissors 4 1/2"

# Hemostatic Forceps



G11-05  
Crile Hemostatic Forceps  
Straight 5 1/2"

G11-06  
Crile Hemostatic Forceps  
Curved 5 1/2"



G11-90  
Crile-Rankin Hemostatic Forceps,  
Straight, 6 1/4"

G11-91  
Crile-Rankin Hemostatic Forceps,  
Curved, 6 1/4"



G22-79  
Hartman Mosquito Forceps,  
Curved Standard Pattern, 3 1/2"

G22-78  
Hartman Mosquito Forceps,  
Straight Standard Pattern, 3 1/2"

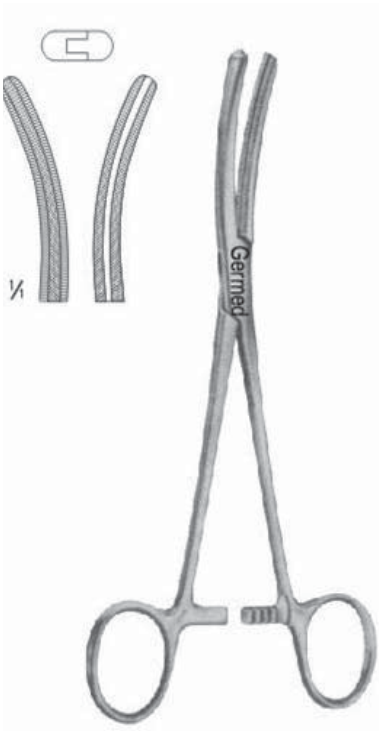

G11-119  
Ferguson Angiotribe Forceps  
Straight 6 1/2"

G11-120  
Ferguson Angiotribe Forceps  
Curved 6 1/2"

G11-121  
Ferguson Angiotribe Forceps  
Straight 7 1/2"

G11-122  
Ferguson Angiotribe Forceps  
Curved 7 1/2"



G11-302  
Jacobson Micro Mosquito Forceps, Straight,  
extremely delicate, Size 5"

G11-304  
Jacobson Micro Mosquito Forceps, Curved,  
extremely delicate, Size 5"

G11-306  
Jacobson Micro Mosquito Forceps, Curved,  
extremely delicate, Size 7"

G11-307  
Jacobson Micro Mosquito Forceps, Straight,  
extremely delicate, Size 7"



G22-76  
Halstead Mosquito Forceps,  
Straight 1x2 Teeth, 5"  
G22-77  
Halstead Mosquito Forceps,  
Curved 1x2 Teeth, 5"



G11-300  
Halstead Mosquito Forceps,  
extra delicate, Straight, Size 5".

G11-301  
Halstead Mosquito Forceps,  
extra delicate, Curved, Size 5".



G11-01  
Halstead Mosquito Forceps  
Straight 5"

G11-02  
Halstead Mosquito Forceps  
Curved 5"



G11-03  
Kelly Hemostatic Forceps  
Straight 5 1/2"  
G11-04  
Kelly Hemostatic Forceps  
Curved 5 1/2"



G11-104  
Peers Towel Clamp,  
Non-Perforating, 5 1/2"

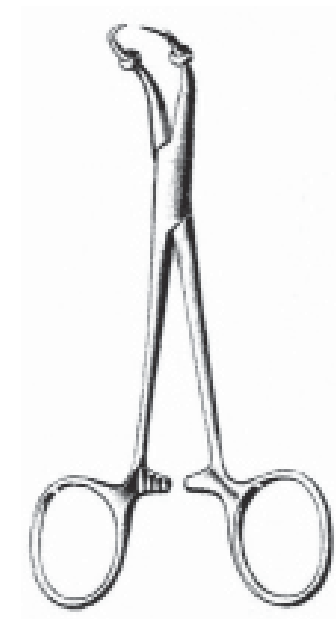

G11-28  
Roeder Towel Clamp 5 1/4"

# Hemostatic Forceps



G11-66  
Providence Hospital Hemostatic  
Forceps Straight 5 1/2"

G11-67  
Providence Hospital Hemostatic  
Forceps Curved 5 1/2"



G11-68  
Rankin-Kelly Forceps Straight  
6 1/4"

G11-69  
Rankin-Kelly Forceps Curved  
6 1/4"



G11-49  
Rochester-Carmalt Forceps  
6 1/4" Straight

G11-50  
Rochester-Carmalt Forceps  
6 1/4" Curved

G11-47  
Rochester-Carmalt Forceps  
8" Straight

G11-48  
Rochester-Carmalt Forceps  
8" Curved



G11-35  
Rochester-Ochsner (Kocher) For-  
ceps, Straight, 1x2 Teeth, 5 1/2"

G11-36  
Rochester-Ochsner (Kocher) For-  
ceps, Curved, 1x2 Teeth, 5 1/2"

## Hemostatic Forceps



G11-43  
Rochester-Ochsner (Kocher)  
Forceps, Straight, 1x2 Teeth, 9"

G11-44  
Rochester-Ochsner (Kocher)  
Forceps, Curved, 1x2 Teeth, 9"

G11-105  
Rochester-Ochsner (Kocher)  
Forceps, Straight, 1x2 Teeth, 10"

G11-107  
Rochester-Ochsner (Kocher)  
Forceps, Curved, 1x2 Teeth, 10"



G11-160  
Thoms-Allis Tissue Forceps,  
6X7 Teeth, 8"



G11-07  
Rochester-Pean Forceps,  
Straight, 6 1/4"

G11-08  
Rochester-Pean Forceps,  
Curved, 6 1/4"

G11-31  
Rochester-Pean Forceps,  
Straight, 7 1/4"

G11-32  
Rochester-Pean Forceps,  
Curved, 7 1/4"

G11-33  
Rochester-Pean Forceps,  
Straight, 8"

G11-34  
Rochester-Pean Forceps,  
Curved, 8"

G11-51  
Rochester-Pean Forceps,  
Straight, 9"

G11-52  
Rochester-Pean Forceps,  
Curved, 9"

G11-99  
Rochester-Pean Forceps,  
Straight, 10"

G11-102  
Rochester-Pean Forceps,  
Curved, 10"

# Hemostatic Forceps



G11-10  
Rochester-Ochsner Forceps  
Curved 6 1/4" 1x2th

G11-09  
Rochester-Ochsner Forceps  
Straight 7 1/4" 1x2th

G11-39  
Rochester-Ochsner Forceps  
Straight 7 1/4" 1x2th

G11-40  
Rochester-Ochsner Forceps  
Curved 7 1/4" 1x2th

G11-41  
Rochester-Ochsner Forceps  
Straight 8" 1x2th

G11-42  
Rochester-Ochsner Forceps  
Curved 8" 1x2th

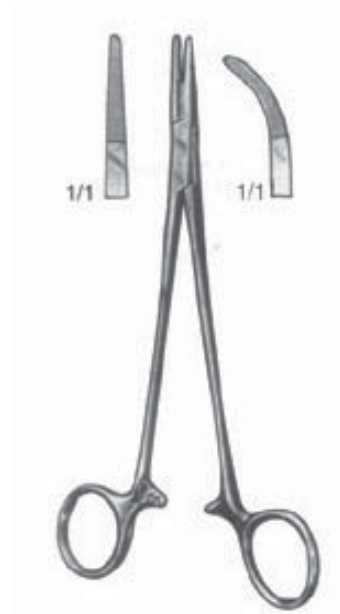

G11-54  
Adson Forceps, Curved, 7 1/4"

G11-53  
Adson Forceps, Straight, 7 1/4"

## Knife Handles



G08-01  
Knife Handle No. 3, Fits  
blades 10-15



G08-06  
Knife Handle No. 3,  
Graduated in Millimeters



G08-02  
Knife Handle No. 3L,  
Long handle for Deep Surgery



G08-03  
Knife Handle No. 4,  
Fits Blades, 20- 25





G08-07  
Knife Handle No. 4,  
Graduated in Millimeters



G08-04  
Knife Handle No. 4L, Fits Blades  
2025, Long Handle for Deep



GD50-1206  
Knife Handle No. 5, Fits Blades  
10-15, Extra Fine, Plastic



GD50-1207  
Knife Handle No. 6, Fits Blades  
20-25, Extra Fine, Plastic



G08-05  
Knife Handle No.7



G08-09  
Knife Handle, Round,  
Fitting blades 10-15



G08-12  
Microsurgical (Beaver) Blade  
Handle 4" in Length

G08-13  
Microsurgical (Beaver) Blade  
Handle 5" in Length

## Measuring



G24-55  
Depth Gauge, Regular

G24-56  
Depth Gauge, Mini Screw



G18-292  
For measuring and marking,  
3 1/4", 8.5 cm



G29-13  
Goniometer Polk Finger 6"  
Graduated cm/inch

## Miscellaneous Instruments

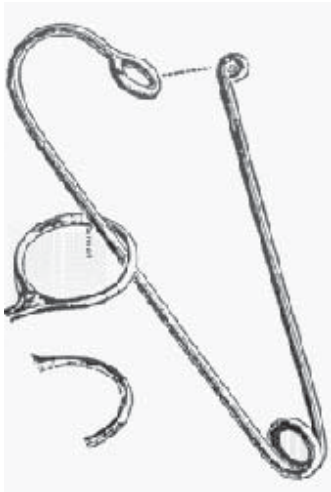

G09-60  
Bunt Forceps Holder



G1110-01  
Quick Lock Tourniquet with 32"  
Neoprene cord  
G1110-02  
Neoprene Cord 32" For Tourni-  
quet



GD50-557  
Sterilizer, Needle, Spiral Rack



G09-05X  
Finger Ring Cutter Blade Only

G09-05  
Finger Ring Cutter With Blade

Nasal Instruments



G20-106  
Gruenwald Nasal Punch 4 1/2" Shaft,  
2 x 10mm Bite

G20-107  
Gruenwald Nasal Punch 4 1/2" Shaft,  
2.5 x 12mm Bite

G20-108  
Gruenwald Nasal Punch, 4 1/2" Shaft,  
3 X 12mm Bite



G20-109  
Meltzer Adenoids Nasal Punch  
5" Shaft, Large Round Jaws, Size

## Nasal Instruments

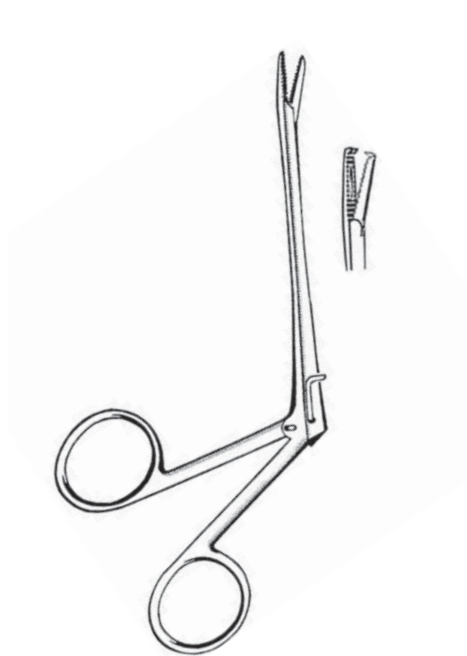

G19-144  
Hartman-Noyes Ear Forceps,  
Alligator Type, Serr, 3" Shaft



G20-69  
Noyes Alligator Forceps,  
Serrated Shaft, 5 1/2"

G20-70  
Noyes Alligator Forceps, Ser-  
rated Shaft, 6 1/2"



G14-16  
Collier Needle Holder 5"

## Needle Holder



G14-07  
Webster Needle Holder,  
Smooth Jaws, 5"



G18-46  
Barraquer Needle Holder,  
Straight, Smooth Jaws with Lock, 5  
1/2"

G18-52  
Barraquer Needle Holder,  
Smooth Jaws 5 1/4"

G18-51  
Barraquer Needle Holder,  
Delicate Curved Jaw with lock 5  
1/4"

## Needle Holders



G18-55  
Castroviejo Needle Holder, 5  
1/2", Straight Jaw Without Catch

G18-56  
Castroviejo Needle Holder,  
Straight, Smooth with Lock 5 1/2"

G18-57  
Castroviejo Needle Holder, 5 1/4",  
Curved Jaw With Catch

G18-392  
Castroviejo Needle Holders, With-  
out Lock, Curved, 5 1/2"



G17-155  
Castroviejo Needle Holder,  
Straight, Smooth with Lock,  
Tungsten Carbide, 5 1/2"



G17-46  
Mayo Hegar Needle Holders,  
Serrated, 7", Tungsten Carbide

G17-47  
Mayo Hegar Needle Holders,  
Serrated, 8", Tungsten Carbide

G17-48  
Mayo Hegar Needle Holders,  
Serrated, 9", Tungsten Carbide

G17-49  
Mayo Hegar Needle Holders,  
Serrated, 10 1/2", Tungsten Carbide

G17-131  
Mayo Hegar Needle Holder,  
Tungsten Carbide, 12"



G14-43  
Mayo Hegar Needle Holder 5  
1/4"

G14-03  
Mayo Hegar Needle Holder 6"

G14-04  
Mayo Hegar Needle Holder 7"

G14-05  
Mayo Hegar Needle Holder 8"

G17-160  
Mayo Hegar Needle Holder,  
Serrated, 5 1/4", Tungsten Carbide

G17-45  
Mayo Hegar Needle Holders,  
Serrated, 6", Tungsten Carbide

## Needle Holders



G14-18  
Baby Olsen-Hegar Needle Holder,  
4 1/2", Tungsten Carbide



G14-41  
Olsen-Hegar Needle Holder,  
European Pattern, 6 1/2"



G14-12  
Olsen-Hegar Combined Needle  
Holder & Scissors 5 1/2"

G14-13  
Olsen-Hegar Combined Needle  
Holder & Scissors 6 1/2"

G14-06  
Olsen-Hegar Combined Needle  
Holder & Scissors 7 1/4"



G17-128  
Olsen-Hegar Combined Needle  
Holder and Scissors, Delicate,  
Serr, 4 3/4", Tungsten Carbide

G17-68  
Olsen-Hegar Needle Holder,  
Tungsten Carbide, 5 1/2"

G17-55  
Olsen-Hegar Combined Needle  
Holder and Scissors, 6 1/4", Serr,  
Tungsten Carbide

G17-69  
Olsen-Hegar Needle Holder,  
Tungsten Carbide, 7 1/2"



G14-38  
Micro Surgery Needle Holder, 7  
1/8", Straight Jaws With Lock

G14-39  
Micro Surgery Needle Holder, 7  
1/8", Curved Jaws With Lock

G14-34  
Micro Surgery Needle Holder 7 1/8",  
Straight Jaws

G14-36  
Micro Surgery Needle Holder 7 1/8",  
Curved Jaws



G14-00  
Halsey Needle Holder,  
Serrated Jaws, 5"

G14-08  
Halsey Needle Holder,  
Smooth Jaws, 5"

G14-37  
Micro Surgery Needle Holder, 5 1/4"  
G14-35  
Micro Surgery Needle Holder 5 1/4",  
Curved Jaws



G17-66  
Halsey Needle Holder,  
Tungsten Carbide, Serrated Jaw, 5"

G17-67  
Halsey Needle Holder,  
Tungsten Carbide, Smooth Jaw, 5"



G14-10  
Heaney Needle Holder Curved,  
8 1/4"

G14-110  
Heaney Needle Holder Curved,  
10"



G17-165  
Heaney Needle Holder,  
Tungsten Carbide, Curved, 10"

## Needle Holders



G14-90  
Crile-Wood Needle Holder,  
Tungsten Carbide, 7"

G14-91  
Crile-Wood Needle Holder,  
Tungsten Carbide, 8"

G14-92  
Crile-Wood Needle Holder,  
Tungsten Carbide, 9"

G17-133  
Crile-Wood Needle Holder,  
Tungsten Carbide, 10"

G17-134  
Crile-Wood Needle Holder,  
Tungsten Carbide, 12"



G14-02  
Crile-Wood Needle  
Holder, Standard 6"



G40-08  
Cruciate Needle Holder,  
Tungsten Carbide Jaws, 7"



G17-83  
Derf Needle Holder, Serrated,  
4 3/4", Tungsten Carbide

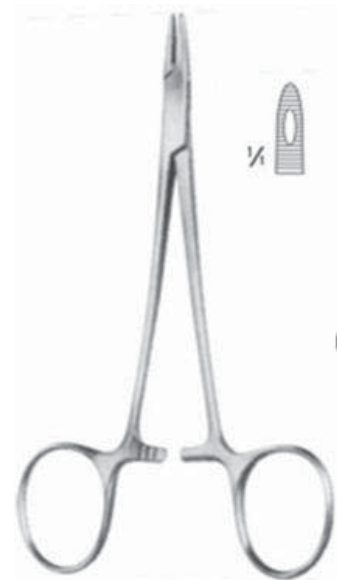

G14-15  
Derf Needle Holder 4 3/4" Serrated





G17-135  
Ryder (French Eye) Needle  
Holder, Tungsten Carbide, 5"

G17-136  
Ryder (French Eye) Needle  
Holder, Tungsten Carbide, 6"

G17-137  
Ryder (French Eye) Needle  
Holder, Tungsten Carbide, 7"

G17-72  
Ryder (French Eye) Needle  
Holder, Tungsten Carbide, 8"

G17-138  
Ryder (French Eye) Needle  
Holder, Tungsten Carbide, 9"



G17-90  
Mathieu Needle Holder,  
Tungsten Carbide, 5 1/2"

G17-91  
Mathieu Needle Holder,  
Tungsten Carbide, 6 1/2"



G17-164  
Baumgartner Needle Holders,  
Serrated, 5", Tungsten Carbide

G17-44  
Baumgartner Needle Holders,  
Serrated, 5 1/2", Tungsten Carbide



G14-93  
Baumgartner Needle Holder  
5 1/2"

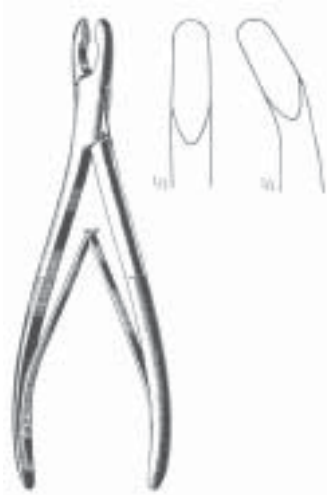

G46-132  
Adson Cranial Rongeur,  
Straight jaws 7 x 13 mm, Size 8"

G46-134  
Adson Cranial Rongeur,  
Curved jaws 7 x 13 mm, Size 8"

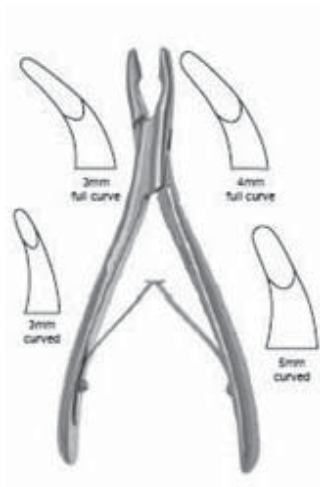

G24-752  
Luer Rongeur 8x10mm Bite  
Straight 7"

G24-754  
Luer Rongeur 8x10mm Bite  
Curved 7"



G19-71  
Luer Rongeurs, Straight, 7"

G19-72  
Luer Rongeurs, Curved, 7"



G24-30  
Stille-Luer Rongeur, Curved 8 3/4"

G24-31  
Stille-Luer Rongeur 8 1/2"  
9x15mm Bite Curved

G24-31S  
Stille-Luer Rongeur 8 1/2" 9x15mm  
Bite Straight

G24-32  
Stille-Luer Rongeur, Curved  
Angled 9"



G46-142  
Fulton Laminectomy Rongeur,  
Straight jaws, 7 x 18 mm, Size 9 1/2"

G46-144  
Fulton Laminectomy Rongeur, slightly  
curved jaws, 7 x 18 mm, Size 9 1/2"



G46-114  
Bailey Saw Guide 12"



G46-116  
Michele Trepine, 6 1/4" shaft

G46-118  
Michele Trepine, 6 1/4" graduated

G46-122  
Michele Trepine, Marker



G46-100  
Gigli Saw Handle, T-Shape turn-  
able, Standard 2 1/2"

G46-102  
Gigli-Strully Saw Handle, T-Shape,  
Rigid with snap lock, Standard.

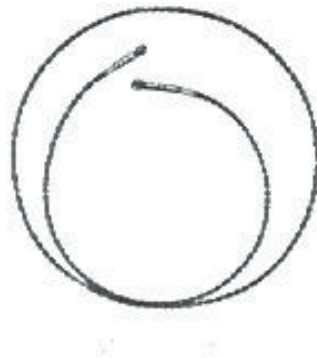

G46-108  
Gigli Saw 12", Standard twisted wire  
type.

G46-110  
Gigli Saw 20", Standard twisted wire  
type.

G46-112  
Gigli Saw 30", Standard twisted wire  
type.



G46-104  
Modified Gigli Bone Saw Wire,  
Turnable  
G46-106  
Modified Gigli Bone Saw Wire,  
Loop Grip



G40-01  
Barraquer Eye Speculum (Colibri)  
1 1/4"  
G40-02  
Barraquer Eye Speculum (Colibri)  
1 1/2"  
G18-44  
Barraquer Eye Speculum Large  
Blades 1 3/4"



G40-04  
Castroviejo Eye Speculum 3 3/4"



G18-45  
Lancaster Eye Speculum 2 3/4"



G40-03  
Graefe Eye Speculum 3 1/2"



G18-186  
Plain Wire Speculum,  
15mm Wide Blades 2 1/2"



G40-07  
Desmarres Chalazion Forceps,  
16mm, 3 1/2"

G18-216  
Desmarres Chalazion Forceps,  
20mm Diameter, 3 1/2"

G18-217  
Desmarres Chalazion Forceps,  
25mm Diameter, 3 1/2"

G18-218  
Desmarres Chalazion Forceps,  
30mm Diameter, 3 1/2"



G18-291  
Eye Suture Scissors, Curved  
Pointed Blades 3 3/4"



G18-194  
Jeweler's Forceps # 7 Swiss Style,  
Extra Fine Tips, Curved, 4 1/2"



G40-05  
Jeweler's Forceps, # 5 Swiss Style,  
Fine Points, Angled, 4 1/2"



G18-193  
Jeweler's Tweezers, #5  
Superfine Point, 4 3/4"



G18-159  
Graefe Fixation Forceps 4 3/8",  
Without Catch

G18-160  
Graefe Fixation Forceps 4 3/8"  
Non magnetic without catch



G19-101  
Jansen Bayonet Forceps,  
Serrated, 7 1/2"

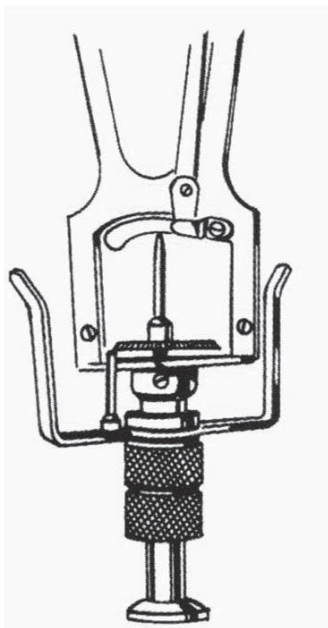

G18-304-1  
Schiotz Tonometer

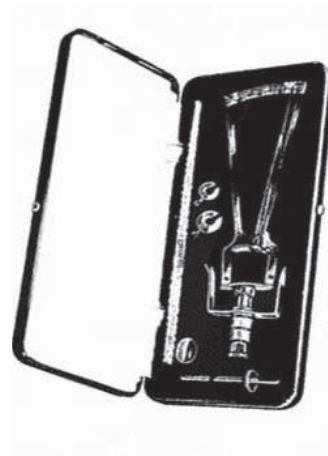

G18-304  
Schiotz Tonometer, Complete  
With Case



G18-304-3  
Sterilizing Case for schiotz tonometers 6 1/2". 3 1/2". 1 1/4" fitted to firmly hold tonometer, weights and test block



G10-SC-48  
Stevens Tenotomy 4 1/2" Straight, Supercut  
G10-SC-49  
Stevens Tenotomy 4 1/2" Curved, Supercut



G17-1201  
Stevens Tenotomy Straight 4 1/2"  
G17-1202  
Stevens Tenotomy Curved 4 1/2"



G18-268  
Stevens Tenotomy Scissors 4 1/2", Slender Style, Straight, With

G18-269  
Stevens Tenotomy Scissors 4 1/2", Slender Style, Slightly Curved, With Blunt

G10-48  
Stevens Tenotomy Scissors, Straight 4 1/4" Blunt Tips

G10-49  
Stevens Tenotomy Scissors, Curved 4 1/4" Blunt Tips

## Ophthalmic Instruments



G18-239  
Strabismus Scissors, Straight,  
4 1/4" / 11.5 cm  
G18-240  
Strabismus Scissors, curved,  
4 1/4" / 11.5 cm



G18-349  
Troutman-Barraquer Colibri Type  
Corneal Utility Forceps, 3", 0.4mm  
G18-350  
Troutman-Barraquer Colibri Type  
Corneal Utility Forceps, 3", 12mm

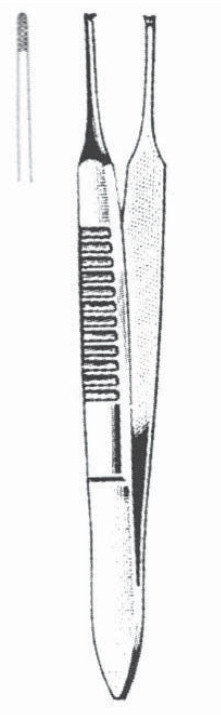

G18-156  
Von Graefe Iris Forceps, 2 3/4"  
Curved, Delicate, 1x2 Teeth  
G18-157  
Von Graefe Iris Forceps, serrated  
tips, curved, delicate, 2 3/4"

## Orthopedic Instruments



G24-60  
Cruciate Repair Crimping Forceps



G46-318  
Dandy Nerve Hook 9"



G14-118  
Ferguson Gall Stone Scoop Double  
Ended, Small, 9 1/2"  
G14-119  
Ferguson Gall Stone Scoop Double  
Ended, Medium, 9 1/2"  
G14-120  
Ferguson Gall Stone Scoop Double  
Ended, Large, 9 1/2"





G21-147  
Freer Elevators, Double Ended  
With Blunt/sharp Blades, 7", 5mm



G13-241  
Mini-Hohman Retractor 6 1/4" 6mm

G13-242  
Mini-Hohman Retractor 6 1/4" 8mm



G13-936  
Hohmann Retractor, 12 mm  
Width, 8"

G13-244  
Hohmann Retractor, 18mm Width,  
8"

G13-246  
Hohmann Retractor, 43mm Width  
8"

G13-660  
Hohmann Retractor, 18 mm Width,  
9"

G13-245  
Hohmann Retractor, 22mm Width,  
9"

G13-247  
Hohmann Retractor, 70mm Width  
9"

G13-243  
Hohmann Retractor 10mm wide,  
9 1/4"



G22-249  
Meniscus Knife 7 1/2"



G24-112  
Cannulated Pin and Wire Cutter  
7 1/2"

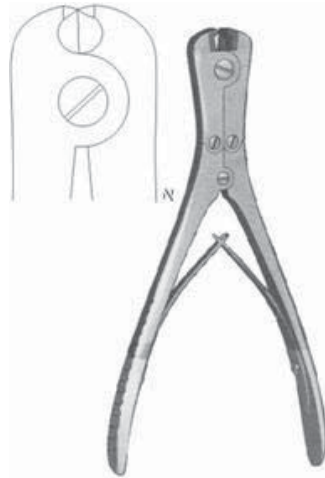

G24-118TC  
C-n-S- front side Pin and Wire  
Cutter

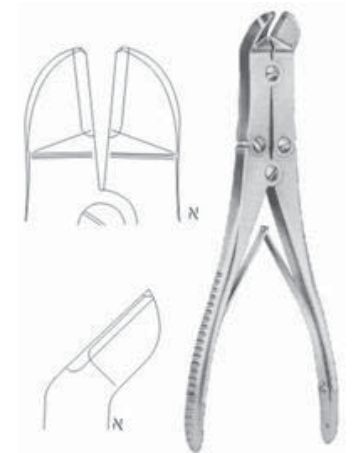

G17-158  
C-N-S- Pin and Wire Cutter TC  
Insert



G24-114  
Diamond Pin and Wire cutter  
6 1/2"



G24-116TC  
Double Action Pin Cutter 15"



G24-37  
Pin Cutter 19"



G24-108  
Wire Twister, Tungsten Carbide  
Insert Jaws, Size 6"  
G24-110  
Wire Twister, Tungsten Carbide  
Insert Jaws, Size 8"



G19-206  
Echlin Rongeur (Duckbill) 9" Angular  
2x15mm Bite  
G19-207  
Echlin Rongeur (Duckbill) 9" Angular  
3x15mm Bite  
G19-208  
Echlin Rongeur (Duckbill) 9" Angular  
4x15mm Bite



G80-01  
Duckbilled Mini-Rongeur 5"



G17-81-01  
K-wire sutter, TC 2.2MM  
G17-81-02  
K-wire sutter, TC 2.5MM



G24-52-08  
Ligament Meniscus Clamp



G24-75  
Graft Curved Passer, 2.0cm

G24-76  
Graft Curved Passer, 3cm

G24-77  
Graft Curved Passer, 4.5cm

G24-78  
Graft Curved Passer, Extra Large

G24-79  
Graft Curved Passer, xx-Large



G22-120  
U.S. Army Pattern Osteo-  
tomes,

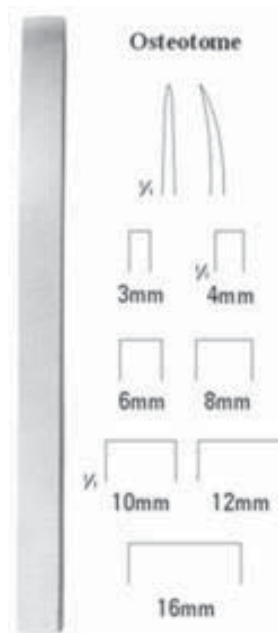

G24-222  
Mini Lambotte Osteotome 5"  
Straight 2mm

G24-224  
Mini Lambotte Osteotome 5"  
Straight 4mm

G24-226  
Mini Lambotte Osteotome 5"  
Straight 6mm

G24-227  
Mini Lambotte Osteotome 5"  
Straight 10mm

G24-228  
Mini Lambotte Osteotome 5"  
Straight 8mm

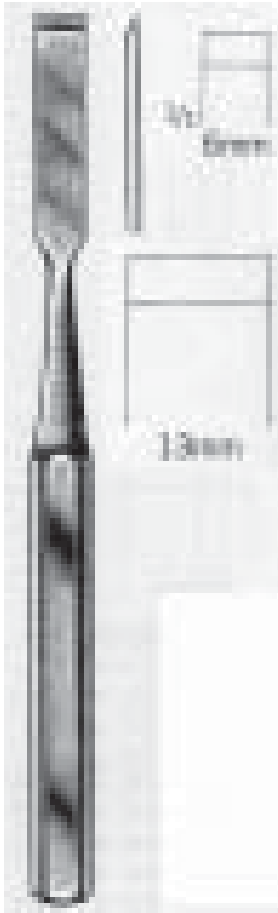

G22-125  
Hoke Osteotomes, 5 1/2",  
Straight, 1/8"

G22-126  
Hoke Osteotomes, 5 1/2",  
Straight, 3/16"

G22-127  
Hoke Osteotomes, 5 1/2",  
Straight, 1/4"

G22-128  
Hoke Osteotomes, 5 1/2",  
Straight, 5/16"

G22-129  
Hoke Osteotomes, 5 1/2",  
Straight, 3/8"

G22-130  
Hoke Osteotomes, 5 1/2",  
Straight, 1/2"



G24-51-06  
K-wire Small Pin Punch



G22-90  
Keyes Cutaneous Punch,  
2 mm Tip, 4" (10cm)

G22-91  
Keyes Cutaneous Punch,  
3 mm Tip, 4" (10cm)

G22-92  
Keyes Cutaneous Punch,  
4 mm Tip, 4" (10cm)

G22-94  
Keyes Cutaneous Punch,  
6 mm Tip, 4" (10cm)

G22-96  
Keyes Cutaneous Punch,  
8 mm Tip, 4" (10cm)

# Orthopedic Instruments



G12-31  
Russian Forceps, 6"  
G12-32  
Russian Forceps, 8"  
G12-33  
Russian Forceps, 10"



G19-10  
Lucae Forceps, Serrated, 5  
1/2"



G45-354  
Lovelace Lung Grasping Forceps, Angled  
shanks serrated jaws 1" wide, 7 1/4"

G45-352  
Lovelace Lung Grasping Forceps, Straight  
serrated jaws 1" wide, 8"



G10-95A  
Economy Utility Scissors,  
Serrated, 5 1/2"  
G10-95  
Economy Utility Scissors,  
Serrated, 7 1/2"



G24-59  
Screwdriver 20mm



G24-65  
Small Pin Hand, Chuck Vise



G24-285  
Mallet Solid Stainless 11" 16oz



G24-275  
Mead Mallet 7 1/2"



G24-260  
Mallet, lightweight, 7.5 oz, Stainless head, Size 7 1/2"

G24-265  
Mallet, lightweight, 9 oz, Stainless head, Size 7 1/2"



G20-57  
Gerzog Mallet, 7 1/2" 7oz

G20-57A  
Gerzog Mallet 7" 16oz

G20-57B  
Gerzog Mallet 7 1/2" 10oz



G20-62  
Lucae Mallet 7 3/4"  
7oz Convex/Flat Head



G20-622  
Lucae Mallet 8" 8oz Convex/  
Flat



G24-39  
Plate Bender Pliers



G24-38  
Parallel Action Wire Cutters

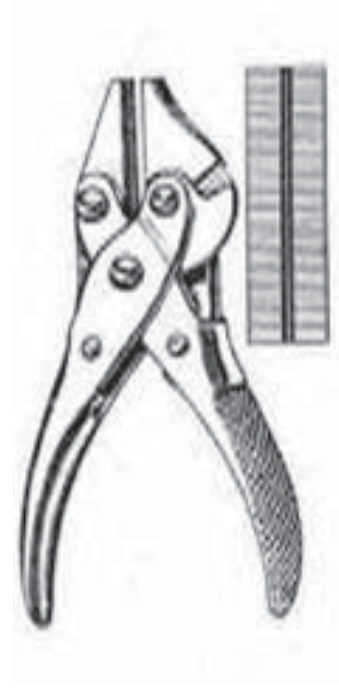

G24-106  
Parallel Action Wire Cutters 4 1/2"

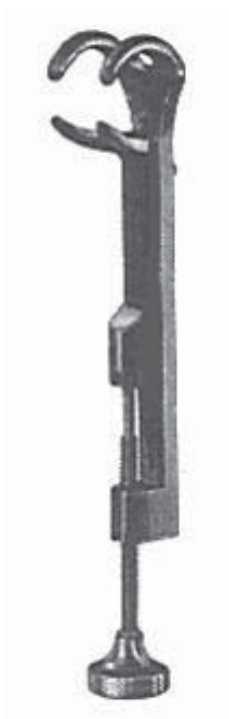

G24-100  
Lambert-Lowman Bone Clamp,  
Bone Clamp 1" Wide



G24-20  
Liston Bone Cutting Forceps,  
Angled, 5 1/2"

G24-16  
Liston Bone Cutting Forceps,  
Straight, 5 1/2"

G24-17  
Liston Bone Cutting Forceps,  
Straight, 7 1/2"

G24-21  
Liston Bone Cutting Forceps,  
Angled, 7 1/2"

G24-52  
Liston Bone Cutting Forceps,  
Angled, 8 3/4"

G24-51  
Liston Bone Cutting Forceps,  
Straight, 8 3/4"



## Orthopedic Instruments

G19-18-01  
Ruskin Bone Cutting Forceps  
Straight 6"



G19-18-02  
Ruskin Bone Cutting Forceps  
Curved 6"

G19-80  
Ruskin Bone Cutting Forceps  
Straight Jaw 7 1/4"

G19-80A  
Ruskin-Liston Cutting Forceps  
Straight, 7 1/2"

G19-81  
Ruskin Bone Cutting Forceps  
Angled Jaw 7 1/4"

G19-81A  
Ruskin-Liston Cutting Forceps,  
Angled, 7 1/2"

G19-227  
Lane Bone Forceps 13"  
Standard Without Ratchet



G19-228  
Lane Bone Forceps 13"  
Standard With Ratchet

G19-229  
Lane Bone Holding For-  
ceps, 17" Standard Without  
Ratchet

G19-230  
Lane Bone Holding Forcps, 17"  
With Ratchet



G19-219  
Kern Bone Holding Forceps 9  
1/2" Without Ratchet

G19-220  
Kern Bone Holding Forceps 9  
1/2" With Ratchet



G24-06  
Lewin Bone Holding Forceps 7"



G24-42  
Verbrugge Bone Holding For-  
ceps, Small

G24-41  
Verbrugge Bone Holding For-  
ceps, Large



G24-43  
Bone Bolding Forceps 5 1/2"



G45-430  
Meeker Kantrowitz Forceps,  
Full Curved Jaws, 7 3/4"



G24-501  
Bone Fragment Forceps 4"  
Regular

G24-500  
Bone Fragment Forceps 6" Large



G24-40  
Wire twister/Shear Cutter



G24-44  
X-small serrated Bone Holding  
Forceps



G11-88  
Micro Mosquito Forceps, Straight,  
Very Delicate Pattern, 4 3/4"

G11-89  
Micro Mosquito Forceps, Curved,  
Very Delicate Pattern, 4 3/4"



G22-24  
Joseph Hook, Double Prong,  
2mm Wide, 6"  
G22-25  
Joseph Hook Double Prong,  
5mm Wide, 6"



G22-34  
Joseph Hook, Sharp Single  
Prong, 6"



G17-100  
Gillies Hook, Small 8"



G501-02  
Snook Hook, Blunt, 8" Solid Tip



G501-01  
Snook Hook, Blunt, 8"



G22-248  
Smillie Knife 6 3/4" Straight



G29-01  
Stille Pattern Drill Set



G15-810  
Eppendorfer-Krause Rotating Shaft  
Biopsy Forceps, Size 9", Shafts are  
interchangeable



G24-152  
Kirschner Wires/ w/flat end 0.9mm 12"

G24-154  
Kirschner Wires/ w/flat end 1.1mm 12"

G24-156  
Kirschner Wires, w/flat end 1.6mm 12"



G10-100  
Engel Cast Cutter 6"



G16-162  
Stille Pattern Vessel Clamp, 9"

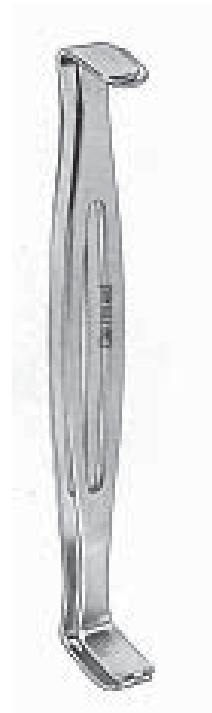

G13-24  
U.S. Army Retractor, .625  
Wide-Set of 2, 8.5"



GD50-701  
Bone File, Double Ended, No.  
10, 7"



GD50-705  
Bone File, Double Ended, No.  
12, 7"



GD50-211  
Bone File, Double Ended, No.  
33, 7"

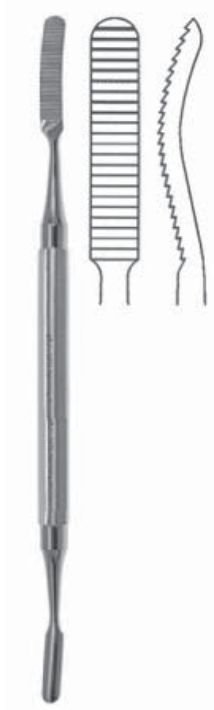

GD50-213  
Bone File, Double Ended, No.  
45, 7"

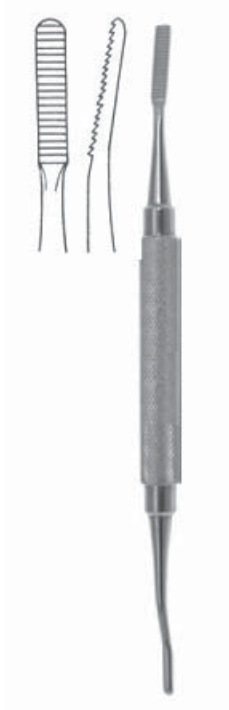

GD50-212  
Bone File, Double Ended, No.  
64, 7"



G22-239  
Key Elevator, 7 1/2", Squared  
.25"

G22-241  
Key Elevator, 7 1/2", Squared .5"

G22-242  
Key Elevator, 8", Squared .75"

G22-243  
Key Elevator, 8 1/4", Squared  
1.0"



G22-328-01  
Excision Arthroplasty Rasp  
170mm



G22-328-02  
Trochlea Rasp 6 3/4"

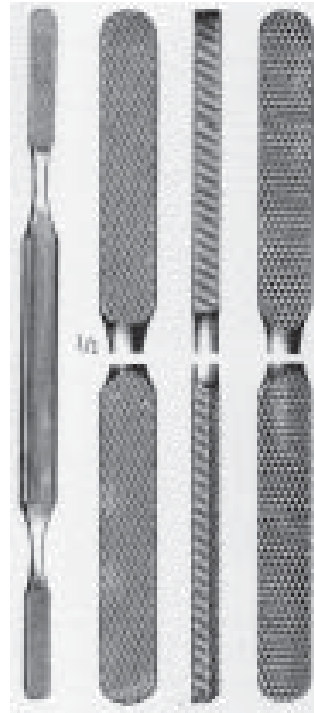

G22-325  
Fomon Rasp, Sided Teeth 8 1/4"

G22-326  
Fomon Rasp, Coarse Teeth 8 1/4"

G22-328  
Fomon Rasp, Fine Teeth 8 1/4"



G16-115  
Mayo Common Duct Scoop Small,  
Malleable, 10 1/2"

G16-116  
Mayo Common Duct Scoop Medium,  
Malleable, 10 1/2"

G16-117  
Mayo Common Duct Scoop Large,  
Malleable, 10 1/2"

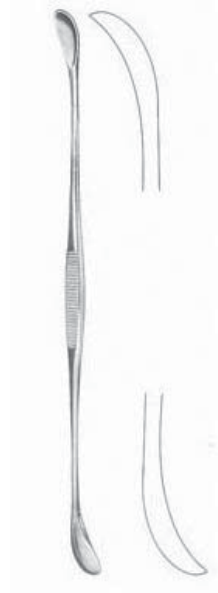

G16-114  
Mayo Gall Stone Scoop,  
Double Ended, 11"/28cm



**V2001-06**  
Basic Periodontal Pack with  
sharpening Stone & Oil

- 1 GD50-774 Tower-Jaquette Scaler
- 1 GD50-757 Columbia Curette
- 1 V25-G-206-01 Gracey Posterior Curette
- 1 V25-G-206-02 Gracey Anterior Curette
- 1 GD50-303-01 Probe/Explorer CP 12/23
- 1 GD50-1134-02 Sharpening Oil
- 1 G11-25-01 Arkanses Flat Stone



**V2001-13**  
Basic Rabbit Dental Pack

- 1 Rongeur
- 1 Rabbit Mouth Gag
- 1 Rasp
- 1 Large Mouth Spatula
- 1 Small Mouth Spatula
- 1 Large Cheek Gag
- 1 Small Cheek Gag





**V2001-12  
Advanced Rabbit Dental Pack**

- |                                   |                                |
|-----------------------------------|--------------------------------|
| 1 G19-76 Lempert-Rongeur          | 1 G21-20-02 Cheek Gag, Small   |
| 1 V70-265 Rabbit Mouth Gag        | 1 G21-20-03 Crossley Luxator#1 |
| 1 G22-15 Lewis rabbit Dental Rasp | 1 G21-20-04 Crossley Luxator#2 |
| 1 G46-25-01 Hollman Mouth Spatula |                                |
| 1 G46-25-02 Hollman Mouth Spatula |                                |
| 1 G21-20-01 Cheek Gag, Large      |                                |



**V2001-03  
Canine/Feline Spay Pack**

- |   |   |
|---|---|
| 1 G08-01 Knife Handle # 3                           | 2 G11-02 Halsted Mosquito Forceps 5" Curved   |
| 1 G10-28 Mayo Scissors 6 3/4" Straight              | 2 G11-04 Kelly Forceps 5 1/2" Curved          |
| 1 G10-39 Metzenbaum Scissors 7" Curved              | 2 G11-50 Roch-Carmalt Forceps 6 1/4 Curved.   |
| 1 G12-06 Tissue Forceps 5 1/2" 1 X 2 Teeth.         | 4 G11-26 Backhaus Towel Clamp 3 1/2"          |
| 1 G12-26 Brown Adson Forceps 4 3/4" 7 X 7<br>Teeth. | 1 G17-55 Olsen - Hegar Needle Holder*         |
|   | 1 G11-20 Allis Tissue Forceps 6" 4 x 5 Teeth. |
|   | 1 G501-01 Snook Ovariectomy Hook              |

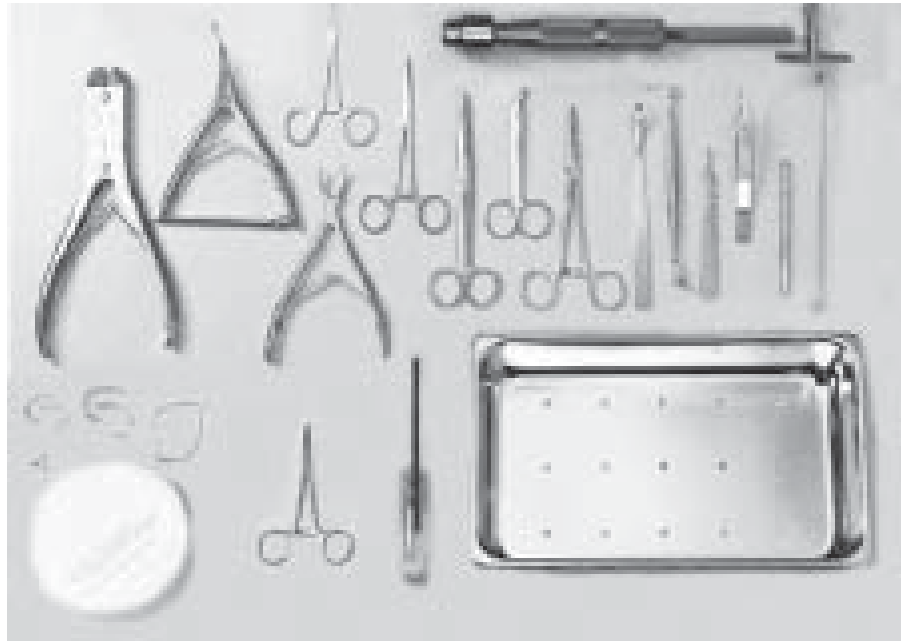

**V2001-20  
Cruciate Packs**

- |  |   |   |
|--|---|---|
| 1 G08-01 #3 Knife Handle                       | 1 G11-02 Halstead Mosquito Forceps 5" Curved  | 1 G21-131 Complete Dual Hand Chuck Pin Smooth 3/32" |
| 1 G10-27 Mayo Scissors 6 3/4" Straight         | 1 G11-05 Crile Forceps 5 1/2" Straight        | 1 G19-77 Lempert Rongeur 6 1/2" Curved              |
| 1 Misc Roger Wire Cutting Scissors 4.75"       | 1 G12-21 Adson Brown Forceps 4 3/4"           | 1 G24-446 Universal Tensioning Device               |
| 1 G19-59 Frazier Suction 10FR                  | 1 G14-13 Olsen Hegar Needle Holder 6 1/2"     | 1 Misc Crimp Tubes                                  |
| 1 G11-01 Halstead Mosquito Forceps 5" Straight | 1 G13-38 Senn Retractor 6 1/4" 3 Sharp Prongs | 1 G09-42 Cruciate Needles Set of 3 sizes            |
|  | 1 G13-958 Hohmann Retractor 6mm               | 1 Misc Monofilament Nylon Suture Tray, Perforated   |
|  | 1 Misc Crimping Forceps                       |   |

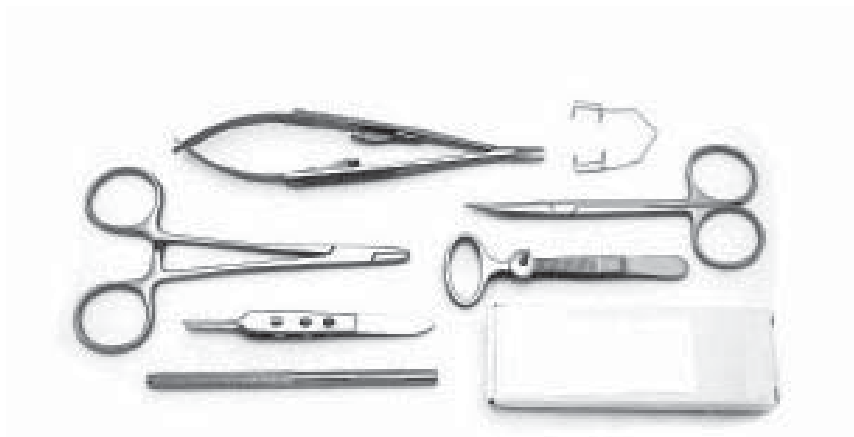

**GV100-04  
German Advanced Eye Pack**

**GV100-05  
Vet Advanced Eye Pack**

- 1 Micro Blade Handle
- 1 Bishop- Harmon Forceps 4x2th 3 1/4" Delicate
- 1 Desmarres Chalazion Forceps 3 1/2" 20mm Wide
- 1 Stevens Tenotomy Scissors Curved
- 1 Barraquer Wire Speculum 1 1/4"
- 1 CastroViejo Needle holder with lock, Smooth Jaws 5 1/2"
- 1 Microbeaver Blade Size 67 box of 12



**GV100-01**  
**German Starter Eye Pack**

**GV100-02**  
**Vet Starter Eye Pack**

- GV100-01**  
 1 Derf Needle holder 4 3/4"  
 1 Bishop- Harmon Forceps 4x2th 3 1/4" Delicate  
 1 Stevens Tenotomy Scissors Curved 4 1/4"  
 1 Barraquer Wire Speculum 1 1/4"

- GV100-02**  
 1 Derf Needle holder 4 3/4"  
 1 Bishop- Harmon Forceps 4x2th 3 1/2" Delicate  
 1 Stevens Tenotomy Scissors Curved 4 1/2"  
 1 Barraquer Wire Speculum 1 1/4"

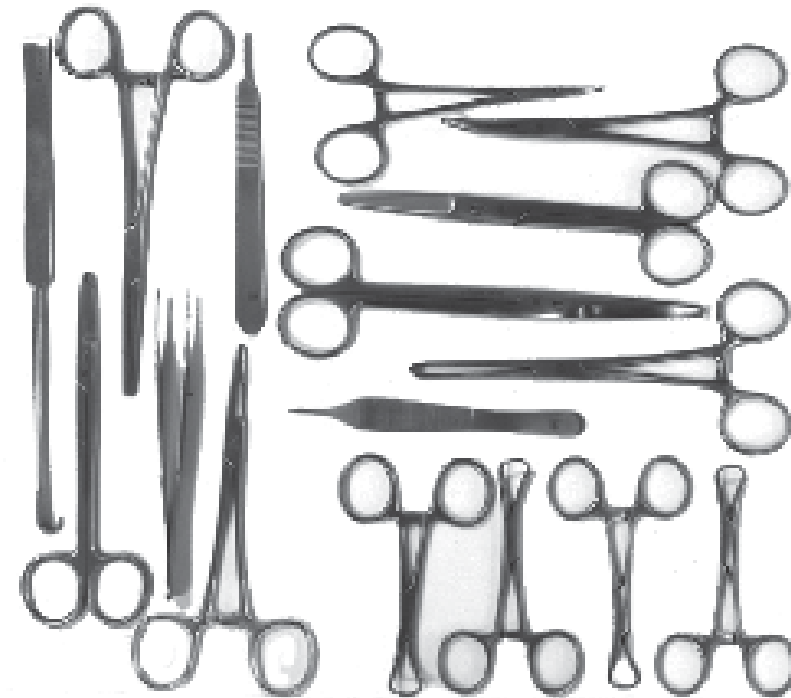

**V2001-02**  
**Spay Pack with Olsen Hegar N.H**

- |                                     |  |
|-------------------------------------|--|
| 1 Operating Scissors S/B Straight   | 4 Backhaus Towel Clamps 3 1/2"                 |
| 1 Adson Brown Tissue Forceps 4 3/4" | 1 Mayo Dissecting Forceps 6 3/4" Str. or Cvd.  |
| 1 Adson Dressing Forceps 4 3/4"     | 1 Kelly Forceps 5 1/2" Str or Cvd              |
| 1 Allis Tissue Forceps 6" 4x5th     | 1 Halstead Mosquito Forceps 5" Str or Cvd      |
| 1 Littauer Stitch Scissors 5 1/2"   | 1 Olsen Hegar Needle Holder 5 1/2" (or) 6 1/2" |
| 1 Surgical Handle #3                |  |
| 1 Snook Hook                        |  |

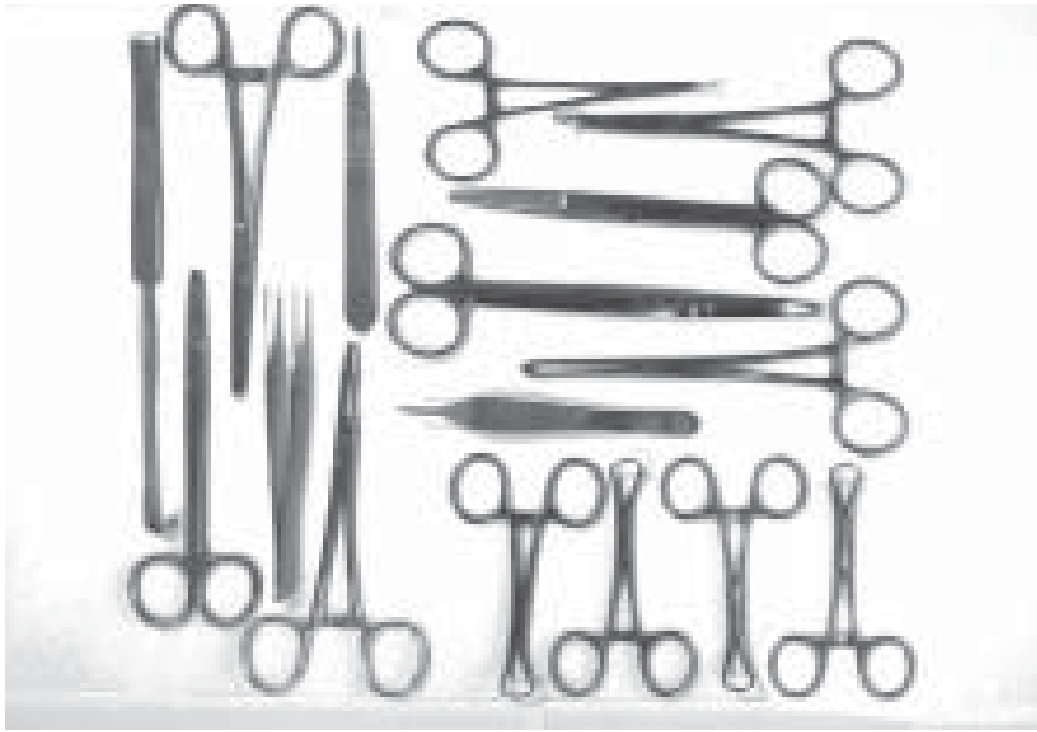

**V2001-01**  
**Spay Pack with Olsen Hegar**  
**N.H.TC Insert**

- |                                     |   |
|-------------------------------------|---|
| 1 Operating Scissors S/B Straight   | 4 Backhaus Towel Clamps 3 1/2"                |
| 1 Adson Brown Tissue Forceps 4 3/4" | 1 Mayo Dissecting Forceps 6 3/4" Str. or Cvd. |
| 1 Adson Dressing Forceps 4 3/4"     | 1 Kelly Forceps 5 1/2" Str or Cvd             |
| 1 Allis Tissue Forceps 6" 4x5th     | 1 Halstead Mosquito Forceps 5" Str or Cvd     |
| 1 Littauer Stitch Scissors 5 1/2"   | 1 Olsen Hegar Needle Holder 5 1/2" or 6 1/2"  |
| 1 Surgical Handle #3                | TC insert                                     |
| 1 Snook Hook                        |   |



**V2001-07**  
**Standard Veterinary Eye Pack**

- |   |
|---|
| 1 VG08-01 Scalpel Handle #3             |
| 1 VG18-44 Wire Eye Speculum             |
| 1 VG18-126 Eye Dressing Forceps 4"      |
| 1 VG10-216 Chalazion Forceps            |
| 1 VG10-48 Stevens Tenotomy Scrs 4" Str. |
| 1 VG10-56 Castroviejo Needle Holder     |



**GV100-06  
Vet Advanced Eye Pack with Case**

- 1 CastroViejo Needle holder with lock, 1 Micro Blade Handle
- Smooth Jaws 5 1/2" 1 Bishop- Harmon Forceps 4x2th 3 1/4" Delicate
- 1 Microbeaver Blade Size 67 box of 12 1 Desmarres Chalazion Forceps 3 1/2" 20mm Wide
- 1 Sterilization Case w/mat 1 Stevens Tenotomy Scissors Curved
- 1 Wire Eye Speculum 1 1/4"



**GV100-03  
Vet Starter Eye Pack with Case**

- 1 Derf Needle holder 4 3/4"
- 1 Bishop- Harmon Forceps 4x2th 3 1/2" Delicate
- 1 Stevens Tenotomy Scissors Curved 4 1/2"
- 1 Barraquer Wire Speculum 1 1/4"
- 1 Sterilization Case w/mat



**V2001-08  
Standard Veterinary Orthopedic  
Pack**

- 2 Senn Retractors
- 1 5.5" Sharp Weitlaner Retractor
- 1 Pair-Gigli Wire Handles
- 1 12" Gigli Wire Saw
- 1 6" Kern Bone Holding Forcep
- 1 8" Kern Bone Holding Forcep
- 1 Mead Mallet
- 1 2mm Bone Curette
- 1 8mm 5" Osteotome
- 1 9.25" Pin Cutter
- 1 Dean Rongeur
- 1 20 Gauge Ortho Wire
- 1 8.5" Fomon Rasp & File
- 1 Freer Elevator

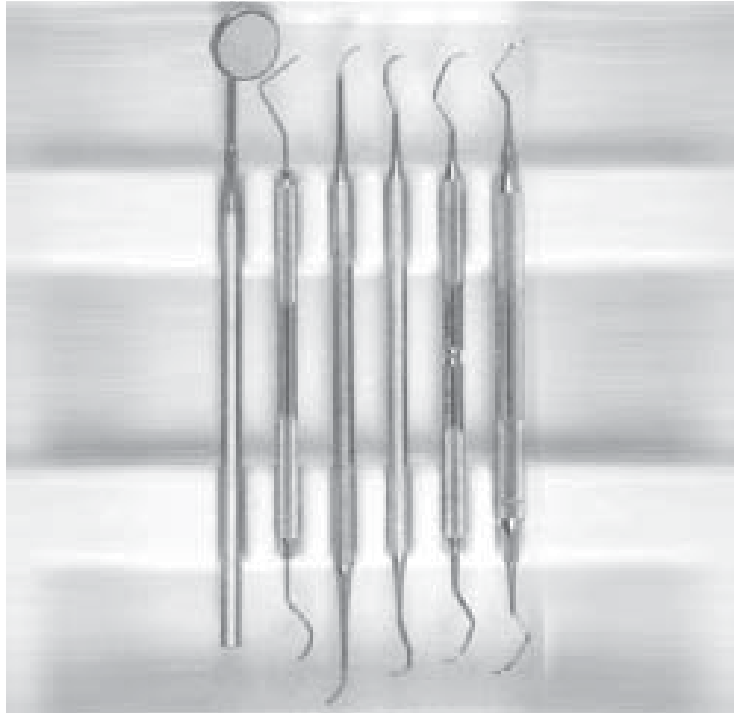

GD50-20-03  
Veterinary Dental Set

- 1-Mirror #4
- 1-Explorer D/E/
- 1-Probe 20-23 Explorer
- 1-Curette Columbia 13-14 Fine
- 1-Curette Columbia 4L-4R
- 1-Scaler Jacquette 2S-3S
- 1-Universal Scaler/1-Sterilizing Tray

## Directors & Probes



G14-115  
Probe with Eye 4 1/2"

G16-14-5  
Probe with Eye 5"

G14-116  
Probe with Eye 5 1/2"

G16-14-6  
Probe with Eye 6"

G16-14-8  
Probe with Eye 8"

G16-14-10  
Probe with Eye 10"

G14-117  
Probe with Eye 12"

## Directors & Probes



GD50-740  
Probe/Explorer, Double Ended, 3,  
6, 9, & 12mm markings



G14-111  
Grooved Director 4 1/2"

G14-112  
Grooved Director 5"

G14-113  
Grooved Director 5 1/2"

G14-114  
Grooved Director 6"



GD50-1537  
Graduated Probe, Style "C"



G13-280  
Baby Ribbon Retractor,  
Malleable 1.0", 7"

G13-285  
Baby Ribbon Retractor,  
Malleable .25", 7"  
G13-286  
Baby Ribbon Retractor,  
Malleable .5", 7"

G13-287  
Baby Ribbon Retractor,  
Malleable .75", 7"

## Retractors



G13-205  
Alm Retractor 2 3/4" 4x4  
Prongs  
G13-206  
Alm Retractor 4" 4x4 Prongs

# Retractors



G13-91  
Baby Weitlaner Retractor 4" Sharp  
2x3 Prongs

G13-92  
Baby Weitlaner Retractor 4" Blunt  
2x3 Prongs



G13-08  
Weitlaner Retractor  
3x4th 6 1/2" Blunt

G13-09  
Weitlaner Retractor 8"  
Blunt 3x4 Prongs

G13-230  
Weitlaner Retractor 9 1/2"  
Blunt 3x4 Prongs

G13-231  
Weitlaner Retractor 9 1/2"  
Sharp 3x4 Prongs



G13-94  
Weitlaner Retractor 5 1/2"  
Blunt

G13-93  
Weitlaner Retractor 5 1/2"  
Sharp 3x4 Prongs

G13-10  
Weitlaner Retractor Sharp,  
3x4th 6 1/2"

G13-11  
Weitlaner Retractor 8" Sharp  
3x4 Prongs



G13-02  
Balfour Abdominal Retractor  
10" Spread, Standard

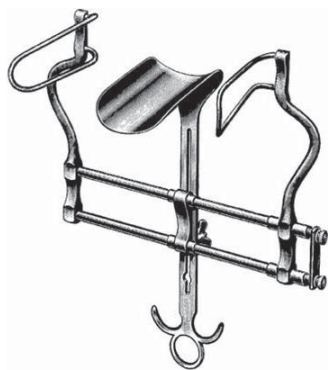

G13-05  
Balfour Abdominal Retractor  
7" Spread



G13-195  
Balfour Abdominal, solid side  
blades 2 3/4" deep, and solid  
center blade 3" x 7" Spread

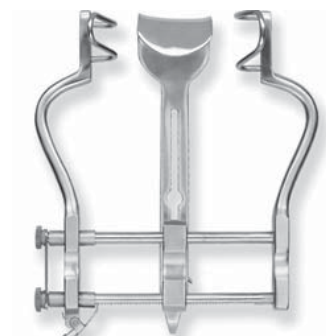

G13-197  
Balfour Abdominal Retractor 5  
1/4" Spread, 2" x 1.65" Blade





G13-04  
Pedatric Balfour Abdominal Retractors With Fenestrated Side Blades And Solid Center Blade 1" deep, 4" Spread,  
G13-06  
Balfour Pediatric Retractor, 3 1/2" Spread



G10-97  
Beeson Cast Spreader 12 1/4"



G10-78  
Cast Spreader Walton 9"

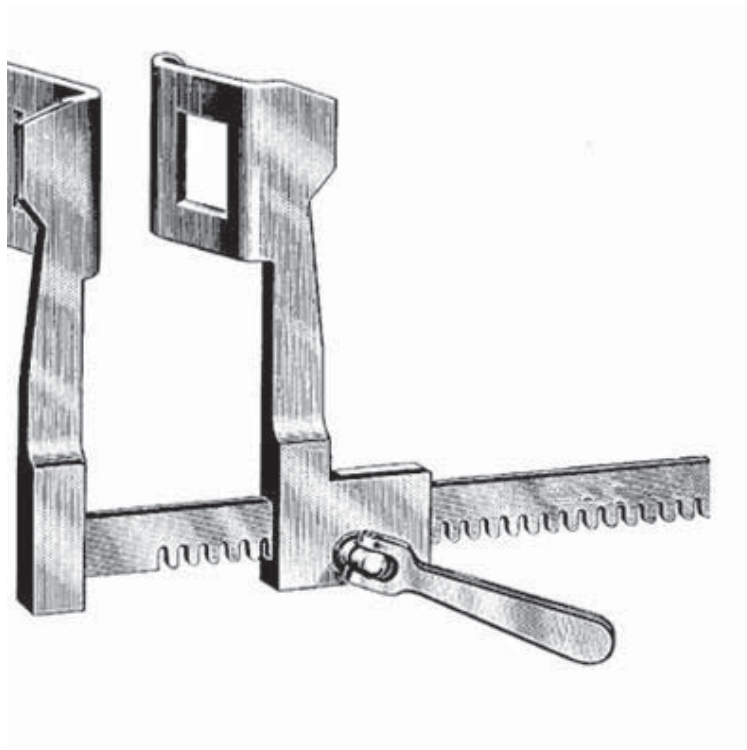

G45-060  
Finochietto Rib Spreader, Original Model, Standard Size, blades 48mm deep x 65mm wide, 8" Spread,

G45-062  
Finochietto Rib Spreader, Original Model, Standard Size, blades 48mm deep x 65mm wide, 10" Spread, Curved arms.

G45-064  
Finochietto Rib Spreader, Original Model, Standard Size, blades 48mm deep x 65mm wide, 12" Spread, Curved arms.

# Retractors



G18-339  
Goldstein Eye Retractor, 3x3  
pointed prongs, 5mm Deep 1 1/8"



G13-255  
Gossett Abdominal Retractor,  
5.5"



G13-601  
Holzheimer Retractor 4"  
4x4 Prongs Sharp  
G13-603  
Holzheimer Retractor 4"  
4x4 Prongs Blunt



G13-189  
Gelpi Retractor With Grip Lock  
6 3/4"



G13-58  
Gelpi Retractor 4 1/2" Right  
Angled  
G13-58R  
Gelpi Retractor Right Angled 5  
1/2"



G80-1981  
Gelpi Retractor 3 1/2"  
G80-1983  
Gelpi Retractor 4 1/2"  
G13-110  
Gelpi Retractor 5 1/4"  
G13-59  
Gelpi Retractor 7"



G46-59  
Hudson Brace, Small

G46-58  
Hudson Brace, Large

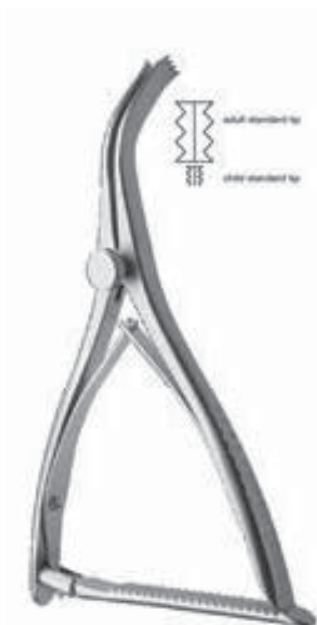

G46-392  
Inge Retractor, 6 1/2"

G46-393  
Inge Retractor, 11"



G13-30  
Meyerding Retractor, 89mm X  
50mm Blade, Large, 10"

G13-31  
Meyerding Retractor, 75mmX-  
25mm Blade, Medium, 10"

G13-32  
Meyerding Retractor, 52mmX-  
16mm Blade, Small, 10"



G18-90-03  
Davis Stifle Retractor 7"  
With Speed Lock, Cross Action



G18-90-01  
Modified Stifle Retractor 18cm



G13-143  
Ragnell Retractor 6" D/E

## Retractors

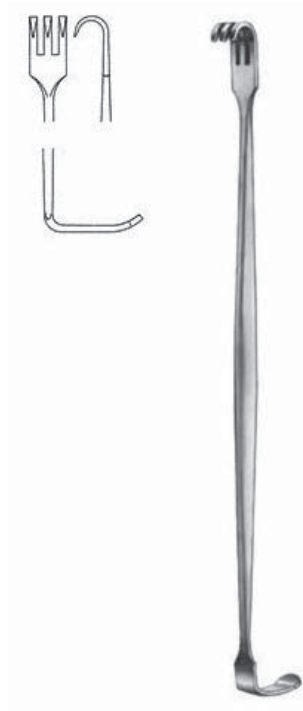

G13-38  
Senn Retractor 3 Prongs Sharp  
6 1/4"

G13-39  
Senn Retractor 3 Prongs Blunt  
6 1/4"



G13-65  
Ribbon Retractor,  
Malleable 1.0", 13"

G13-66  
Ribbon Retractor,  
Malleable 1.25", 13"

G13-67  
Ribbon Retractor,  
Malleable 1.5", 13"

G13-68  
Ribbon Retractor,  
Malleable 2.0", 13"

G13-72  
Ribbon Retractor,  
Malleable 2.5", 13"

G13-73  
Ribbon Retractor,  
Malleable 3.0", 13"

G13-265  
Ribbon Retractor,  
Malleable .75", 13"



G18-90-02  
Small Stifle Retractor 5"  
With Speed Lock, Cross Action



G22-805  
Wallace Knee Retractor, 5"



G13-607  
Lahey Retractor 1 Sharp Prong, 4 3/4"  
G13-609  
Lahey Retractor 2 Sharp Prongs, 4 3/4"  
G13-611  
Lahey Retractor 3 Sharp Prongs, 4 3/4"



G24-830  
Ruskin Rongeur 4x15mm Bite  
Straight 7 1/4"  
G24-836  
Ruskin Rongeur 4x15mm Bite  
Curved 7 1/4"

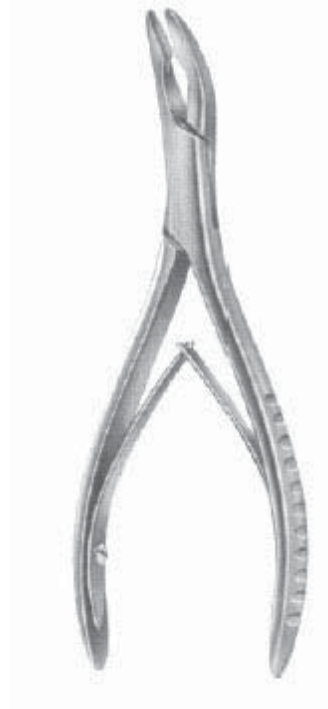

G24-350  
Dean Rongeur 3mm x 10mm  
Bite Curved, 5 3/4"



G19-182  
Ruskin Rongeur 3x10mm  
Bite Curved 6"



G46-227  
Ferris Smith Rongeur 7" 6mmx-  
10mm Straight  
G46-228  
Ferris Smith Rongeur 7" 4mmx-  
10mm Up Angle  
G46-230  
Ferris Smith Rongeur 7" 6mmx-  
12mm Straight  
G46-642  
Ferris Smith Rongeur 7" 6mmx-  
10mm Up Angle  
G46-644  
Ferris Smith Rongeur 7" 6mmx-  
10mm Down Angle



G46-191  
Kerrison Rongeur 7" 1mm Up-  
Bite  
G46-193  
Kerrison Rongeur 7" 1mm  
Down-Bite  
G46-175  
Kerrison Rongeur 7" 2mm Up-  
Bite  
G46-176  
Kerrison Rongeur 7" 3mm Up-  
Bit Thin Foot Plate 40 Degree

## Rongeurs

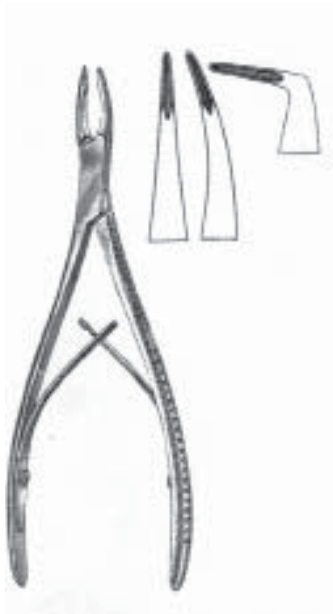

GD50-151  
Micro Friedman Rongeurs, Curved  
Jaws, angled 15 Degrees, 5 1/2"

GD50-152  
Micro Friedman Rongeurs, Curved  
Jaws, Angled, 90 Degrees, 5 1/2"



G24-758  
Adson Rongeur  
17 x 7mm Bite Straight, 8"

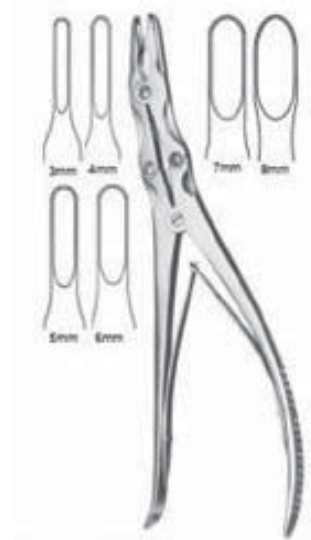

G19-76  
Lempert Rongeur  
2.5mm x 10mm Bite Straight 6 1/2"

G19-77  
Lempert Rongeur  
2.5mm x 10mm Bite Curved 6 1/2"

G24-808  
Leksell Rongeur 9" 4x16mm  
Bite Angled

G24-814  
Leksell Rongeur 9" 7x16mm  
Bite Angled

## Scissors



G10-500  
Canine Ear Cropping Scissors  
6 1/2" Straight- S/B

G10-501  
Canine Ear Cropping Scissors  
6 1/2" Curved- S/B

G10-505  
Canine Ear Cropping Scissors  
6 1/2" Straight- B/B

G10-506  
Canine Ear Cropping Scissors  
6 1/2" Curved- B/B



G10-104  
Baby Metzenbaum Scissors,  
Standard Straight, 4 1/2"

G10-105  
Baby Metzenbaum Scissors,  
Standard Curved 4 1/2"



G18-238  
Stitch Scissors Blunt Blades 3  
3/4" Curved, Fine Tips

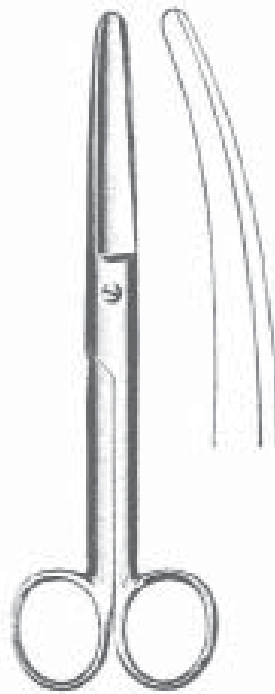

G10-114  
Doyen Abdominal Scissors, 7"  
straight  
G10-115  
Doyen Abdominal Scissors, 7"  
curved



G10-09  
Emergency Room Shears,  
8 1/2" serrated edge



G10-26  
Mayo Dissecting Scissors,  
Straight 5 1/2"

G10-28  
Mayo Dissecting Scissors  
Curved 5 1/2"

G10-27  
Mayo Dissecting Scissors  
Straight 6 3/4"

G10-29  
Mayo Dissecting Scissors,  
Curved, 6 3/4"

G10-67  
Mayo Dissecting Scissors,  
9" straight

G10-68  
Mayo Dissecting Scissors  
Curved 9"

# Scissors



G10-SC-130  
Ragnell Dissecting Scissors  
Straight 5" Supercut  
G10-SC-163  
Ragnell Dissecting Scissors Flat tip  
Curved 7" Supercut



G10-1000  
Operating Scissors Standard pattern  
straight, Sharp/Sharp, 4 1/2"

G10-1100  
Operating Scissors Standard pattern,  
straight, Sharp/Sharp, 5"

G10-1200  
Operating Scissors Standard Pattern  
Straight, Sharp/Sharp 5 1/2"

G10-1400  
Operating Scissors Standard pattern,  
straight, Sharp/Sharp, 6 1/2"

G10-1300  
Operating Scissors Standard pattern,  
straight, Sharp/Sharp, 6"



G10-1501  
Operating Scissors Standard  
pattern, curved, Sharp/Blunt,

G10-1601  
Operating Scissors Standard  
pattern, curved, Sharp/Blunt, 5"

G10-1701  
Operating Scissors Standard  
pattern, curved, Sharp/Blunt, 5

G10-1801  
Operating Scissors Standard  
pattern, curved, Sharp/ Blunt, 6"

G10-1901  
Operating Scissors Standard  
pattern, curved, Sharp/Blunt, 6

G10-2101  
Operating Scissors Standard  
pattern, curved, Sharp/Blunt, 7



## Scissors

G10-1500  
Operating Scissors Standard pattern, curved, Sharp/Sharp, 4 1/2"



G10-1600  
Operating Scissors Standard pattern, curved, Sharp/Sharp, 5"

G10-1700  
Operating Scissors Standard pattern, curved, Sharp/Sharp, 5 1/2"

G10-1800  
Operating Scissors Standard pattern, curved, Sharp/Sharp, 6"

G10-1900  
Operating Scissors Standard pattern, curved, Sharp/Sharp, 6 1/2"



GD50-263  
Iris Scissors, Straight Tungsten Carbide, 4 1/2"  
GD50-265  
Iris Scissors, Curved Tungsten Carbide, 4 1/2"



G10-1001  
Operating Scissors Standard pattern, straight, Sharp/Blunt 4 1/2"

G10-1101  
Operating Scissors Standard pattern, straight, Sharp/Blunt, 5"

G10-1201  
Operating Scissors Standard pattern, Straight, Sharp/Blunt, 5 1/2"

G10-1301  
Operating Scissors Standard pattern, straight, 6"

G10-1401  
Operating Scissors Standard pattern, straight, Sharp/Blunt 6 1/2"

G10-2001  
Operating Scissors Standard pattern, straight, Sharp/Blunt, 7 1/2"



G10-1002  
Operating Scissors Standard pattern, straight, Blunt/Blunt, 4 1/2"

G10-1102  
Operating Scissors Standard pattern, straight, Blunt/Blunt, 5"

G10-1202  
Operating Scissors Standard pattern, straight, Blunt/Blunt, 5 1/2"

G10-1302  
Operating Scissors Standard pattern, straight, Blunt/Blunt, 6"

G10-1402  
Operating Scissors Standard pattern, straight, Blunt/Blunt, 6 1/2"



G10-1502  
Operating Scissors, Standard pattern, curved, Blunt/Blunt, 4

G10-1602  
Operating Scissors, Standard pattern, curved, Blunt/Blunt 5"

G10-1702  
Operating Scissors, Standard pattern, curved, Blunt/Blunt, 5 1/2"

G10-1802  
Operating Scissors, Curved, Blunt/Blunt, 6"

G10-1902  
Operating Scissors, Curved Blunt/Blunt, 6 1/2"

## Scissors

G10-SC-1700  
Operating Scissors Standard Pattern, sharp/sharp, Curved 5 1/2"

G10-SC-1200  
Operating Scissors Standard Pattern, sharp/sharp, Straight 5 1/2", Supercut

G10-SC-1202  
Operating Scissors Standard pattern, straight, Blunt/Blunt, 5 1/2", Supercut

G10-SC-1201  
Operating Scissors Standard pattern, Straight, Sharp/Blunt, 5 1/2", Supercut

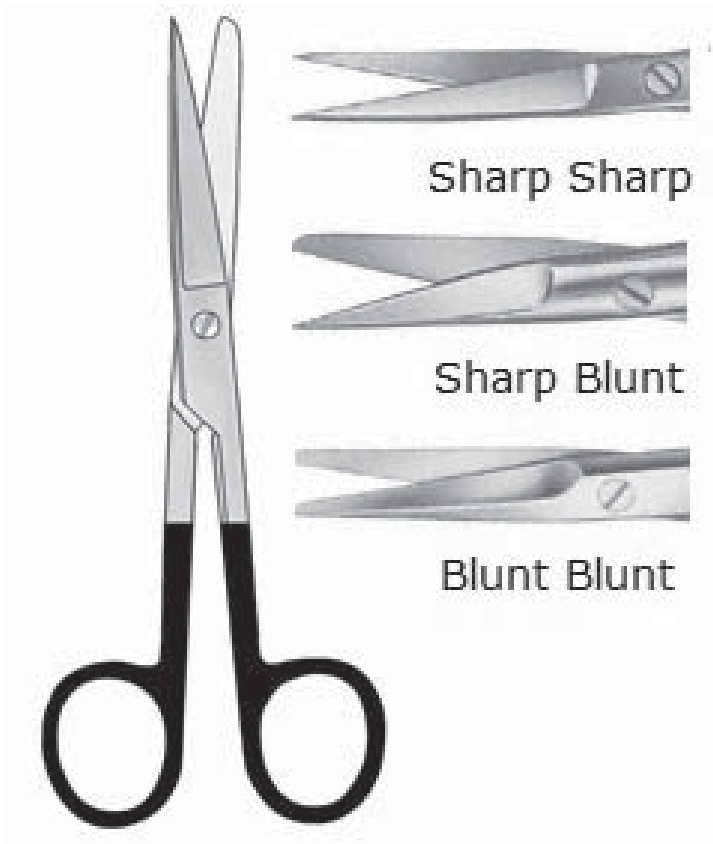

G17-1203  
Gradle Scissors Curved 3 3/4"

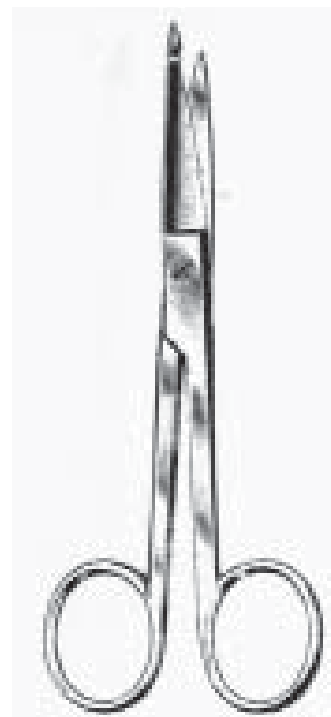

G10-71  
Knowles Bandage Scissors,  
Straight 5 1/2"

# Scissors



G10-01  
Lister Bandage Scissors  
3 1/2"

G10-05  
Lister Bandage Scissors  
8" With One Large Ring.

G10-02  
Lister Bandage Scissors  
4 1/2"

G10-107  
Lister Bandage Scissors  
8"

G10-03  
Lister Bandage Scissors  
5 1/2"

G10-04  
Lister Bandage Scissors  
7 1/4"



G10-06  
Hi-Level Bandage Scissors,  
Angled 5 1/2"



G10-07  
Feline Bandage Scissors, 7"



G18-394  
Iris Scissors 3 1/2" , Curved,  
Blunt Points

G18-393  
Iris Scissors 3 1/2" Straight,  
With Blunt Points

G18-256  
Iris Scissors, 3 1/2" Straight,  
With Sharp Tips

G18-257  
Iris Scissors, 3 1/2" Curved,  
With Sharp Tips

G18-248  
Iris Scissors, 4" Straight, With-  
Sharp Points

G18-246  
Iris Scissors, 4" Curved, With-  
Sharp Points

G10-44  
Iris Scissors, 4 1/2", Straight,  
With Sharp Points

G10-45  
Iris Scissors 4 1/2" Curved,  
With Sharp Tips



G10-141  
Metzenbaum Dissecting Scissors Str  
5" Delicate

G10-153  
Metzenbaum Dissecting Scissors Str 6"  
Delicate

G10-154  
Metzenbaum Dissecting Scissors, Deli-  
cate, 7" straight

G10-40  
Metzenbaum Dissecting Scissors Curved  
8" Delicate

G10-143  
Metzenbaum Dissecting, Delicate,  
9" straight



G22-47  
Metzenbaum Scissors (Lahey),  
Straight, 5.75", Standard

G22-48  
Metzenbaum Scissors (Lahey),  
Curved, 5.75", Standard

G10-208  
Metzenbaum Scissors (Lahey),  
Pedifine Curved, 4 1/2", Stan-

G10-212  
Metzenbaum Scissors (Lahey),  
Pedifine Straight, 4 1/2"

## Scissors



G10-36  
Metzenbaum Scissors 5 1/2"  
Straight, Standard

G10-133  
Metzenbaum Dissecting  
Scissors Straight 5"

G10-137  
Metzenbaum Dissecting  
Scissors Curved 5"

G10-37  
Metzenbaum Scissors  
Straight 7"

G10-39  
Metzenbaum Dissecting  
Scissors Curved 7"

G10-146  
Metzenbaum Scissors  
Curved 8"

G10-134  
Metzenbaum Scissors  
Straight 9"

G10-138  
Metzenbaum Scissors  
Curved 9"

G10-136  
Metzenbaum Scissors  
Straight 14 1/2"



G10-120  
Metzenbaum Scissors (Nelson),  
Straight Delicate, 7", Tungsten

G10-216  
Metzenbaum Scissors (Nelson),  
Curved, 7", Standard

G10-226  
Metzenbaum Scissors (Nelson),  
Straight, 7", Standard

G10-218  
Metzenbaum Scissors (Nelson),  
Curved, 8", Standard

G10-228  
Metzenbaum Scissors (Nelson),  
Straight, 8", Standard

G10-222  
Metzenbaum Scissors (Nelson),  
Straight, 9", Standard

G10-119  
Metzenbaum Scissors (Nelson),  
Curved, 9", Standard

G10-224  
Metzenbaum Scissors (Nelson),  
Straight, 10", Standard

G10-2150  
Metzenbaum Scissors (Nelson),  
Curved, 10", Standard

G10-225  
Metzenbaum Scissors (Nelson),  
Straight, 11", Standard

G10-139  
Metzenbaum Scissors (Nelson),  
Curved, 11", Standard



G17-205  
Metzenbaum Scissors (Lahey), Curved  
Delicate, 5.75", Tungsten Carbide

G17-206  
Metzenbaum Scissors (Lahey), Curved  
Sharp-Sharp, 5.75", Tungsten Carbide

G17-207  
Metzenbaum Scissors (Lahey), Curved  
Standard, 5.75", Tungsten Carbide

G17-209  
Metzenbaum Scissors (Lahey), Straight  
Delicate, 5.75", Tungsten Carbide

G17-211  
Metzenbaum Scissors (Lahey), Straight  
Standard, 5.75", Tungsten Carbide

G17-213  
Metzenbaum Scissors (Lahey), Straight  
Sharp-Sharp, 5.75", Tungsten Carbide



G17-214  
Metzenbaum Scissors (Nelson),  
Curved Delicate, 7", Tungsten

G17-217  
Metzenbaum Scissors (Nelson),  
Curved, 7", Tungsten Carbide

G17-227  
Metzenbaum Scissors (Nelson),  
Straight, 7", Tungsten Carbide

G17-223  
Metzenbaum Scissors (Nel-  
son), Straight, 9", Tungsten

G17-219  
Metzenbaum Scissors (Nelson),  
Straight Delicate, 9", Tungsten

G17-215  
Metzenbaum Scissors (Nelson),  
Curved Delicate, 9", Tungsten

# Scissors

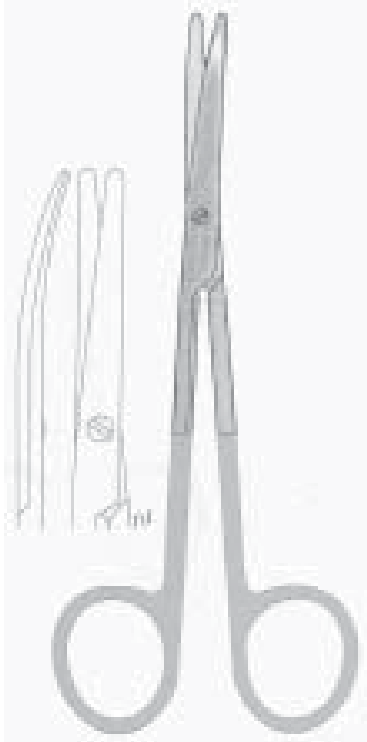

G17-17  
Metzenbaum Scissors Tungsten Carbide  
Insert, Standard, curved, 5 1/2"/ 14.5 cm

G17-32  
Metzenbaum Scissors, Tungsten Carbide  
Insert, Delicate, Curved, 5 1/2"/ 14.5 cm

G17-29  
Metzenbaum Scissors, Tungsten Carbide  
Insert, Delicate, Straight, 5 1/2"/ 14.5 cm

G17-18  
Metzenbaum Scissors Tungsten Carbide  
Insert, Standard, Curved, 7"/ 17.5 cm

G17-31  
Metzenbaum Scissors, Tungsten Carbide  
Insert, Delicate, Straight, 9"/ 22.5m

G17-30  
Metzenbaum Scissors, Tungsten  
Carbide Insert, Delicate, Straight,  
7" 17.5 cm

G17-33  
Metzenbaum Scissors, Tungsten  
Carbide Insert, Delicate, Curved, 7"

G17-19  
Metzenbaum Scissors Tungsten  
Carbide Insert, Standard, Curved, 8"/

G17-34  
Metzenbaum Scissors, Tungsten  
Carbide Insert, Delicate, Curved, 9"

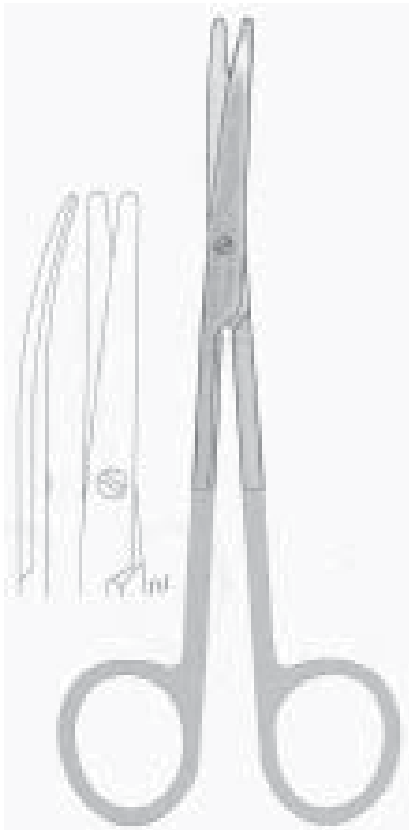

G17-13  
Metzenbaum Scissors Tungsten  
Carbide Insert, Straight, 5 1/2"/ 14.5

G17-14  
Metzenbaum Scissors, Tungsten  
Carbide Insert, Standard, Straight,  
7"/ 17.5 cm

G17-15  
Metzenbaum Scissors, Tungsten  
Carbide Insert, Standard, Straight,  
8"/ 20 cm

G17-16  
Metzenbaum Scissors, Tungsten  
Carbide Insert, Standard, Straight,  
9"/ 22.5 cm

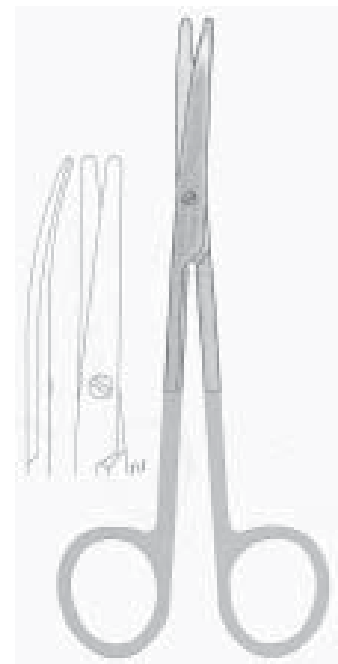

G17-120  
Metzenbaum Scissors, Tungsten  
Carbide Insert, Standard, Curved,  
11"/ 27.5 cm





G17-10  
Mayo Dissecting Scissors 6 3/4"  
Straight Tungsten Carbide

G17-12  
Mayo Dissecting Scissors 6  
3/4" Curved Tungsten Carbide

G17-113  
Mayo Dissecting Scissors,  
Tungsten Carbide Insert, Curved, 9"

G17-112  
Mayo Dissecting Scissors,  
Tungsten Carbide Insert, Straight, 9"



G17-06  
Mayo Stille Scissors, Tungsten  
Carbide Insert, Straight, 6 3/4"

G17-08  
Mayo Stille Scissors, Tungsten  
Carbide Insert, Curved, 6 3/4"

G17-09  
Mayo Dissecting Scissors 5  
1/2" Straight Tungsten Carbide

G17-11  
Mayo Dissecting Scissors 5 1/2"  
Curved Tungsten Carbide



G17-1200  
Goldman Fox, Curved 5",  
Tungsten Carbide



G17-35  
Operating Scissors, Straight, Blunt/  
Blunt Tungsten Carbide 5 1/2"

G17-38  
Operating Scissors, Tungsten Carbide  
Insert, curved, blunt/blunt, 5 1/2"

G17-37  
Operating Scissors, Straight, Sharp/  
Sharp Tungsten Carbide 5 1/2"

G17-36  
Operating Scissors, Straight, Sharp-  
Blunt Tungsten Carbide 5 1/2"

G17-390  
Operating Scissors, Tungsten Carbide  
Insert, curved, sharp/blunt, 5 1/2"

G17-40  
Operating Scissors, Tungsten Carbide  
Insert, curved, sharp/sharp, 5 1/2"

## Scissors

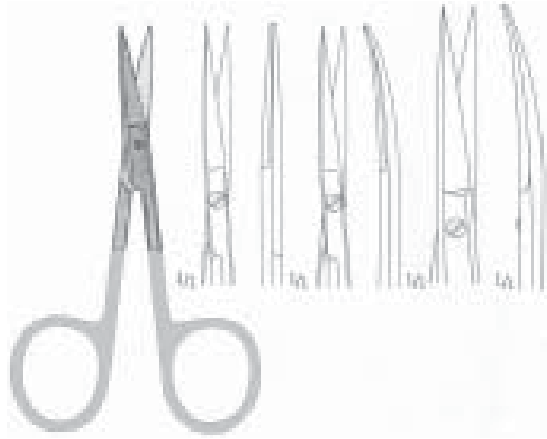

G17-01  
Iris Scissors, Tungsten Carbide  
Inserts, Straight, 4 1/2" / 11.5 cm

G17-02  
Iris Scissors, Tungsten Carbide  
Inserts, Curved, 4 1/2" / 11.5 cm



GD50-SC-766  
Goldman Fox Scissors, Curved  
5", SUPERCUT

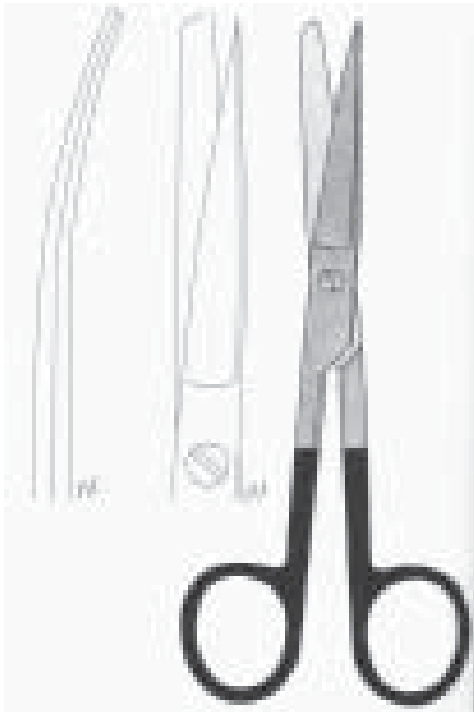

G10-SC-28  
Mayo Dissecting Scissors Curved  
5 1/2" SUPERCUT

G10-SC-26  
Mayo Dissecting Scissors Straight,  
5 1/2" SUPERCUT

G10-SC-29  
Mayo Dissecting Scissors Curved  
6 3/4" SUPERCUT

G10-SC-27  
Mayo Dissecting Scissors Straight,  
6 3/4" SUPERCUT

G10-SC-69  
Mayo Dissecting Scissors 7"  
Curved SUPERCUT

G10-SC-67  
Mayo Dissecting Scissors 9"  
Straight SUPERCUT



G18-SC-387  
Gradle Scissors, Curved 3 3/4",  
SUPERCUT



G10-SC-44  
Iris Scissors, Straight Supercut,  
4 1/2"  
G10-SC-45  
Iris Scissors, Curved Supercut,  
4 1/2"



G10-SC-100  
Baby Metzenbaum Scissors, Supercut,  
Curved, 4 1/2" Supercut  
G10-SC-105  
Baby Metzenbaum Scissors, Supercut,  
Straight, 4 1/2", Supercut



G10-SC-140  
Metzenbaum Curved 4 1/2"  
Supercut



G10-SC-136  
Metzenbaum Straight 4 1/2"  
Supercut

G10-SC-137  
Metzenbaum Scissors 5"  
Curved, Supercut

G10-SC-38  
Metzenbaum Scissors 5 1/2"  
Curved Supercut

G10-SC-145  
Metzenbaum Dissecting Scissors  
Delicate Curved 5 3/4" (Lahey)  
SUPERCUT

G10-SC-36  
Metzenbaum Scissors 5 1/2"  
Straight, Supercut

G10-SC-229  
Metzenbaum Scissors, Supercut,  
Curved, 5 1/2"

G10-SC-230  
Metzenbaum Scissors, Supercut,  
Straight, 5 1/2"

G10-SC-39  
Metzenbaum Scissors 7"  
Curved, Supercut

G10-SC-37  
Metzenbaum Scissors, Supercut,  
Straight, 7"

G10-SC-154  
Metzenbaum Dissecting Scissors  
Delicate Straight 7" SUPERCUT

G10-SC-129  
Metzenbaum Dissecting Scissors  
Delicate Curved 7" Supercut

G10-SC-143  
Metzenbaum Dissecting Scissors  
Delicate Straight 9" SUPERCUT

G10-SC-119  
Metzenbaum Dissecting Scissors  
Delicate Curved 9" (nelson) Supercut

# Scissors



G10-41  
Spencer Stitch Scissors 3 1/2"  
G10-54  
Spencer Stitch Scissors 3 1/2"  
Delicate  
G10-52  
Spencer Stitch Scissors, 4 3/4"

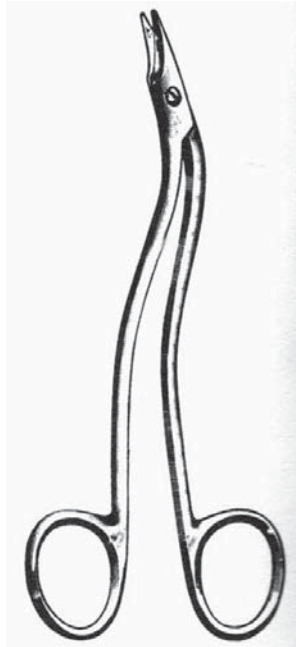

GD50-413  
Suture Scissors, Long, 6 1/4"



G10-43  
Littauer Stitch Scissors, 5 1/2" Straight  
G10-51  
Littauer Stitch Scissors, 4 1/2" straight



G10-42  
Northbent Stitch Scissors 3 1/2"  
G10-42A  
Northbent Stitch Scissors,  
Curved Sideways, 4 1/2"



G10-50  
Wire Cutting Scissors 4 3/4"  
Angled, One Serrated Blade



G10-605  
Roger Wire Cutting Scissors, Serrated  
Angular, 4 3/4", Tungsten Carbide

G10-603  
Roger Wire Cutting Scissors, Serrated  
Angular Carbide Edge, 4 3/4"



G10-604  
Wire Cutting Scissors, Straight,  
4 1/4"



G20-06  
Killian Canine Speculum 2"

G20-08  
Killian Canine Speculum 3"

G20-09  
Killian Canine Speculum 3 1/2"

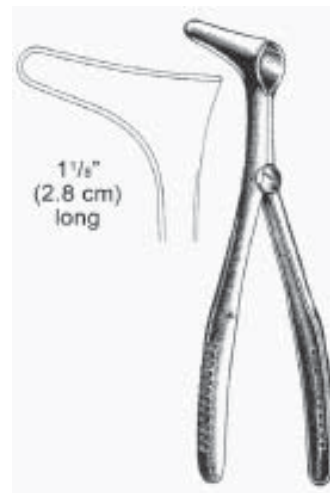

G20-01  
Vienna Felina Vaginal Speculum,  
Small

G20-02  
Vienna Felina Vaginal Speculum,  
Medium

G20-03  
Vienna Felina Vaginal Specu-  
lum, Large

Sterile Surgical Blades

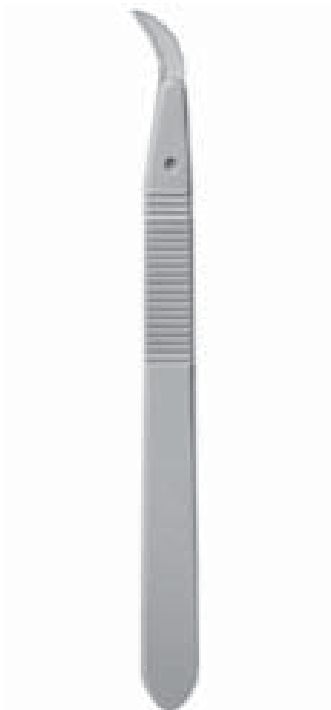

G08-45  
Disposable Scalpel, Stainless Steel  
Blade, Plastic Handle, Size 12

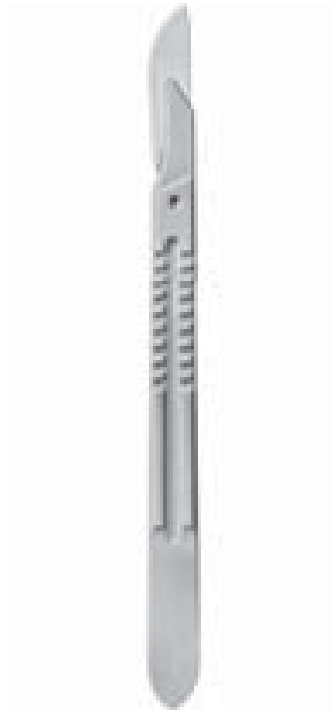

G08-48  
Disposable Scalpels, Stainless  
Steel Blade, Plastic Handle, Size 21



G08-43  
Sterile Surgical Blades, Box of  
100, Stainless Steel, Size 9



G08-20  
Sterile Surgical Blades, Box of  
100, Carbon Steel Size 10



G08-21  
Sterile Surgical Blades, Box of  
100, Carbon Steel Size 11



G08-22  
Sterile Surgical Blades, Box of  
100, Carbon Steel Size 12



G08-23  
Sterile Surgical Blades, Box of  
100, Carbon Steel Size 12B



G08-24  
Sterile Surgical Blades, Box of  
100, Carbon Steel Size 15



G08-25  
Sterile Surgical Blades, Box of  
100, Carbon Steel Size 15C



G08-26  
Sterile Surgical Blades, Box of  
100, Carbon Steel Size 20



G08-27  
Sterile Surgical Blades, Box of  
100, Carbon Steel Size 21



G08-28  
Sterile Surgical Blades, Box of  
100, Carbon Steel Size 22



G08-29  
Sterile Surgical Blades, Box of  
100, Carbon Steel Size 23



G08-30  
Sterile Surgical Blades, Box of  
100, Carbon Steel Size 25



G08-34  
Sterile Surgical Blades, Box of  
100, Stainless Steel, Size 12

## Sterile Surgical Blades

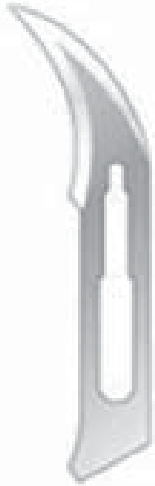

G08-35  
Sterile Surgical Blades, Box of  
100, Stainless Steel, Size 12B



G08-36  
Sterile Surgical Blades, Box of  
100, Stainless Steel, Size 15



G08-33  
Sterile Surgical Blades, Box of  
100, Stainless Steel, Size 11



G08-37  
Sterile Surgical Blades, Box of  
100, Stainless Steel, Size 15C



G08-38  
Sterile Surgical Blades, Box of  
100, Stainless Steel, Size 20



G08-39  
Sterile Surgical Blades, Box of  
100, Stainless Steel, Size 21





G08-40  
Sterile Surgical Blades, Box of  
100, Stainless Steel, Size 22



G08-41  
Sterile Surgical Blades, Box of  
100, Stainless Steel, Size 23

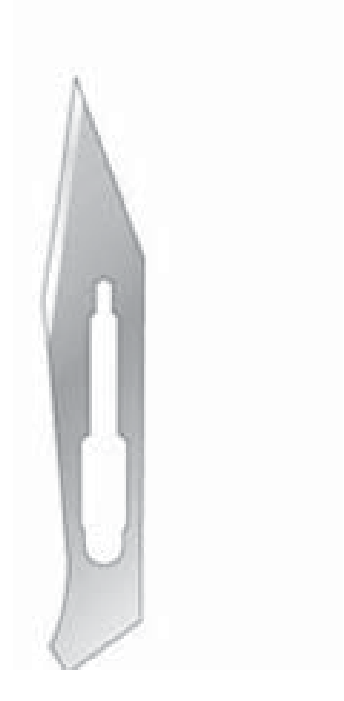

G08-42  
Sterile Surgical Blades, Box of  
100, Stainless Steel, Size 25

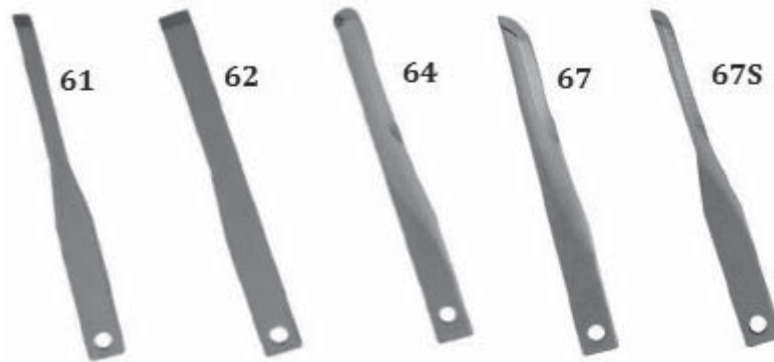

G08-61  
Sterile Surgical Blade Beaver,  
Style 61, 12/Box

G08-62  
Sterile Surgical Blade Beaver,  
Style 62, 12/Box

G08-64  
Sterile Surgical Blade Beaver,  
Style 64, 12/Box

G08-67S  
Sterile Surgical Blade Beaver,  
Style 67 Slim, 12/Box

G08-67  
Sterile Surgical Blade Beaver,  
Style 67, 12/Box

# Surgical Needles



G17-80-24  
Heavy Duty Cruciate Needle  
Driver, Tungsten Carbide



GD20-169  
Keith Abdominal Surgical  
Needle, Straight Triangular Point

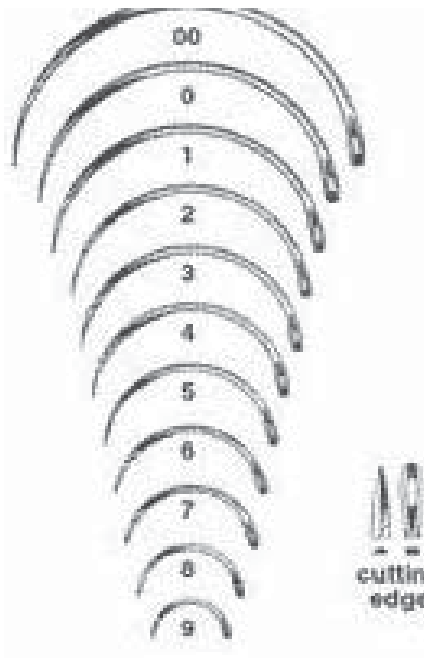

GD20-162  
Surgical Needle, Circle, Cutting  
Edge, Regular Eye



GD20-164  
Surgical Needle, Circle Cutting  
Edge, Veterinary Heavy Pattern

# Surgical Needles



GD20-166  
Loopuyt Surgical Needle,  
Cutting Edge

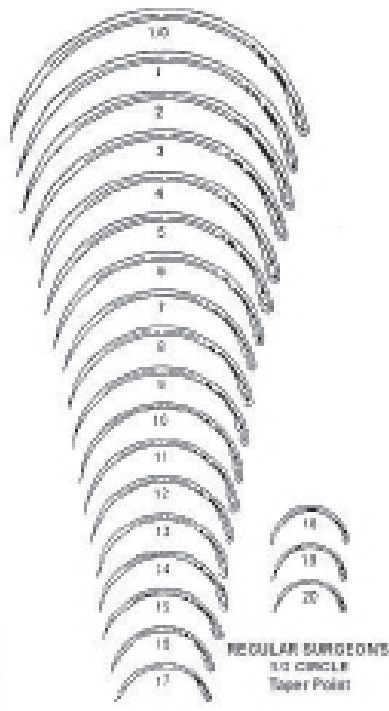

GD20-156  
Surgical Needle, 1/2 Circle  
Cutting Edge

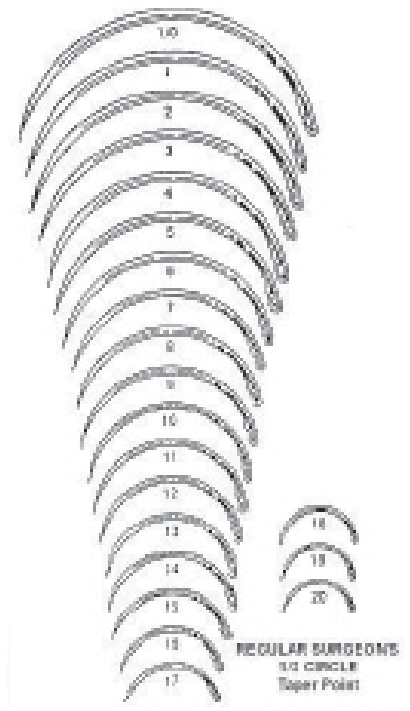

GD20-157  
Surgical Needle, 1/2 Circle Cutting  
Edge, Regular Surgeons



GD20-165  
Surgical Needle, Half Circle  
Cutting Edge, Veterinary Heavy



GD20-161  
Surgical Needle, Half Circle,  
Cutting Edge

# Surgical Needles

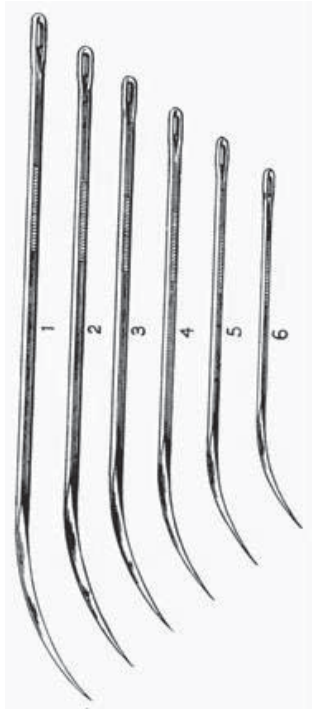

GD20-167  
Surgical Needle, Half Curved  
Heavy pattern, Cutting Edge



GD20-159  
Surgical Needle, Half Curved,  
Cutting Edge, Regular

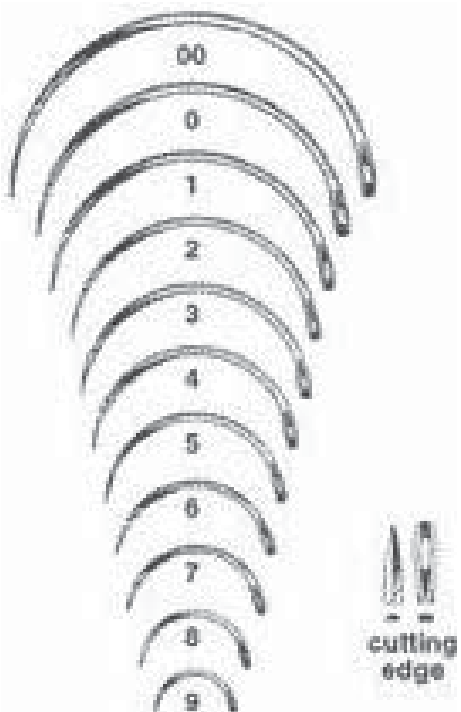

GD20-163  
Surgical Needle, Regular Eye

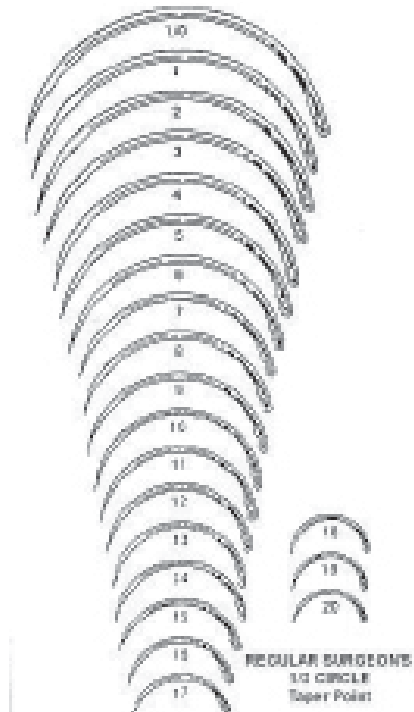

GD20-158  
Surgical Needle, Spring Eye



GD20-168  
Surgical Needle, Double curved  
Heavy Pattern



GD20-160  
Surgical Needle, Spring Eye



GD20-163-01  
Surgical Needle, With spring eye

Suture



G18-158  
Bonn Suture Forceps, 0.12  
For Microsurgery

## Suture



GD50-1055  
Stainless Steel, 18 Guage, Dia  
.040"

GD50-1057  
Stainless Steel, 20 Guage, Dia  
.032"

GD50-1059  
Stainless Steel, 22 Guage, Dia  
.025"

GD50-1062  
Stainless Steel, 24 Guage, Dia  
.020"

GD50-1064  
Stainless Steel, 25 Guage, Dia  
.018"

GD50-1066  
Stainless Steel, 26 Guage, Dia  
.016"

GD50-1068  
Stainless Steel, 28 Guage, Dia  
.012"

GD50-1071  
Stainless Steel, 30 Guage, Dia  
.010"

GD50-1073  
Stainless Steel, 32 Guage, Dia  
.008"

GD50-1075  
Stainless Steel, 34 Guage, Dia  
.006"

GD50-1077  
Stainless Steel, 36 Guage, Dia  
.005"

GD50-1079  
Stainless Steel, 38 Guage, Dia  
.004"

GD50-1082  
Stainless Steel, 40 Guage, Dia  
.003"

## Thoracic Forceps

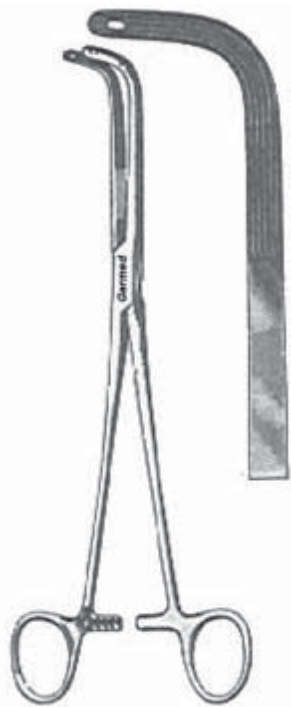

G45-436  
Finochietto Thoracic Forceps,  
slightly curved jaws, 9"

G45-438  
Finochietto Thoracic Forceps and  
Ligature Carrier 9 1/2", angular  
jaws longitudinal serrations

## Towel Clamps & Sponge Forceps



G11-26  
Backhaus Towel Clamp, 3 1/2"

G11-64  
Backhaus Towel Clamps 4 1/2"

G11-27  
Backhaus Towel Clamp, 5 1/4"



G7-20-H  
Hoff Non Perforated Towel Clamp  
5 1/4"

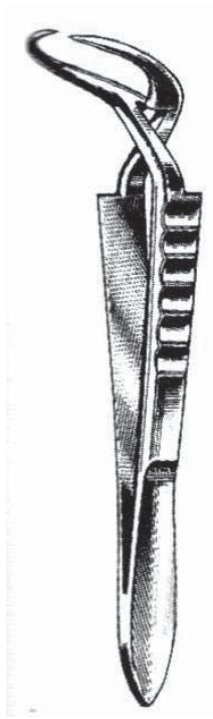

G11-138  
Jones Towel Clamp,  
Light Weight 2 1/4"  
G11-137  
Jones Towel Clamp, 3"

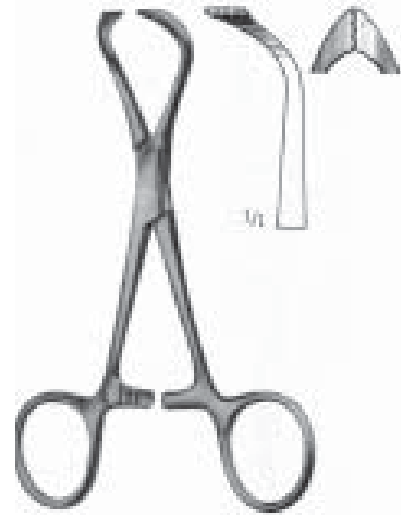

G11-139  
Lorna Non-Perforated Towel  
Clamp 3 1/2"  
G11-140  
Lorna Edna Towel Clamp,  
Non-Perforating, 5 1/4"



G11-11  
Foerster Sponge Forceps, Serrated  
Jaws Straight, 7"

G11-12  
Foerster Sponge Forceps, Serrated  
Jaws Curved, 7"

G11-13  
Foerster Sponge Forceps, Serrated  
Jaws Straight, 9 1/2"

G11-14  
Foerster Sponge Forceps, Serrated  
Jaws Curved, 9 1/2"



G11-179  
Young Tongue Forceps,  
Interchangeable rubber jaw, 6 1/2"

# INDEX

## A

Adson Bayonet Dressing Forceps, Serrated, 8 1/4".....	22
Adson Cranial Rongeur, curved jaws 7 x 13 mm, Size 8".....	50
Adson Cranial Rongeur, Straight jaws 7 x 13 mm, Size 8".....	50
Adson Dressing Forceps 4 3/4" Serrated.....	22
Adson Dressing Forceps, Delicate, Serrated Jaws 4 3/4".....	22
Adson Forceps 4 3/4" 1x2th.....	22
Adson Forceps 4 3/4" Micro With 1x2th.....	23
Adson Forceps 4 3/4" Micro With Serrations.....	23
Adson Forceps, Curved, 7 1/4".....	40
Adson Forceps, Straight, 7 1/4".....	40
Adson Rongeur 17 x 7mm Bite Straight, 8".....	86
Adson Tissue and Suture Forceps, 4 3/4",tying platform.....	23
Adson Tissue Forceps, 1x2 with Carbide Suture Platform.....	23
Adson Tissue Forceps, 2x3 Teeth Delicate, 4 3/4".....	23
Adson Tissue Forceps, Cross Serrated Atraumatic.....	24
Adson-Brown Forceps, 9x9 teeth, side grasp, 4 3/4".....	24
Advanced Rabbit Dental Pack.....	73
Allis Adair Tissue Forceps, 9X10 Teeth, 6".....	24
Allis Tissue Forceps 4x5th 7 1/2".....	34
Allis Tissue Forceps, 3X4 Teeth, 6".....	25
Allis Tissue Forceps, 3X4Teeth, 6".....	25
Allis Tissue Forceps, 4X5 Teeth, 6".....	25
Allis Tissue Forceps, 5X6 Teeth, 6".....	25
Allis Tissue Forceps, 5X6 Teeth, 7 1/2".....	25
Allis-Willauer Tissue Forceps, 5X6 Teeth, 10".....	24
Alm Retractor 2 3/4" 4x4 Prongs.....	79
Alm Retractor 4" 4x4 Prongs.....	79
Apical Del 303 Elevator, 5 3/4".....	6
Autoclavable Front Surface Fiberglass Mirror,#4 and 5 White.....	16

## B

Babcock Abdominal Forceps, 8".....	34
Babcock Abdominal Forceps, 9 1/2".....	34
Baby Allis Tissue Forceps 5 1/2" Delicate.....	25
Baby Allis Tissue Forceps 5" Extra Delicate.....	25
Baby Doyen Intestinal Forceps Curved 6 1/2".....	34
Baby Doyen Intestinal Forceps Straight 6 1/2".....	34
Baby Metzenbaum Scissors, Standard Curved 4 1/2".....	86
Baby Metzenbaum Scissors, Standard Straight, 4 1/2".....	86
Baby Metzenbaum Scissors, Supercut, Curved, 4 1/2".....	99
Baby Metzenbaum Scissors, Supercut, Straight, 4 1/2".....	99
Baby Olsen-Hegar Needle Holder, 4 1/2", TC.....	46
Baby Ribbon Retractor, Malleable .25", 7".....	79
Baby Ribbon Retractor, Malleable .5", 7".....	79
Baby Ribbon Retractor, Malleable .75", 7".....	79
Baby Ribbon Retractor, Malleable 1.0", 7".....	79
Baby Weitlaner Retractor 4" Blunt 2x3 Prongs.....	80
Baby Weitlaner Retractor 4" Sharp 2x3 Prongs.....	80
Backhaus Towel Clamp, 3 1/2".....	110
Backhaus Towel Clamp, 5 1/4".....	110
Backhaus Towel Clamps 4 1/2".....	110
Bailey Saw Guide 12".....	51

Balfour Abdominal Retractor 5 1/4" Spread, 2" x 1.65" Blade.....	80
Balfour Abdominal Retractor 7" Spread.....	80
Balfour Abdominal, solid side blades 2 3/4"x 7" Spread.....	80
Balfour Pediatric Retractor, 3 1/2" Spread.....	81
Bane Mastoid Rongeur, Curved, 7".....	30
Baron Suction Tube, Size 3 French, 7 1/2".....	32
Baron Suction Tube, Size 5 French, 7 1/2".....	32
Baron Suction Tube, Size 7 French, 7 1/2".....	32
Barraquer Eye Speculum (Colibri) 1 1/2".....	52
Barraquer Eye Speculum (Colibri) 1 1/4".....	52
Barraquer Eye Speculum Large Blades 1 3/4".....	52
Barraquer Needle Holder, Delicate Curved Jaw with lock 5 1/4".....	44
Barraquer Needle Holder, Smooth Jaws 5 1/4".....	44
Barraquer Needle Holder, Straight, Smooth Jaws with Lock, 5 1/2".....	44
Basic Periodontal Pack with sharpening Stone & Oil.....	72
Basic Rabbit Dental Pack.....	72
Baumgartner Needle Holder 5 1/2".....	49
Baumgartner Needle Holders, Serrated, 5 1/2", Tungsten Carbide.....	49
Baumgartner Needle Holders, Serrated, 5", Tungsten Carbide.....	49
Beasley Babcock Tissue Forceps, Cross Points, 4 3/4".....	25
Billeau Ear Loops, Delicate, 6 1/2", Large Loop.....	30
Billeau Ear Loops, Delicate, 6 1/2",medium Loop.....	30
Billeau Ear Loops, Delicate, 6 1/2",small Loop.....	30
Bishop Harmon Dressing Forceps Extra Delicate.....	25
Bishop Harmon Dressing Forceps Straight, 1 x 2 Teeth.....	25
Bishop Harmon Dressing Forceps, Straight Tips 3 3/8".....	25
Bone File, Double Ended, No. 10, 7".....	69
Bone File, Double Ended, No. 12, 7".....	69
Bone File, Double Ended, No. 33, 7".....	69
Bone File, Double Ended, No. 45, 7".....	70
Bone File, Double Ended, No. 64, 7".....	70
Bone Fragment Forceps 4" Regular.....	66
Bone Fragment Forceps 6" Large.....	66
Bone Holding Forceps.....	66
Bonn Suture Forceps, 0.12 For Microsurgery.....	109
Bonney Tissue Forceps, 1X2 Teeth, 7".....	25
Bonney Tissue Forceps, 2x3 Teeth, 7".....	26
Brown Tissue Forceps, double rows of 8x8 teeth, Size 6".....	26
Brown-Adson Side Grasping Fcps, 4 3/4", 7X7th.....	24
Brown-Adson Tissue Forceps, 7x7 side grasping.....	24
Buck Ear Curette, 5 3/4", Angled Sharp, Size 0.....	31
Buck Ear Curette, 5 3/4", Angled Sharp, Size 1.....	31
Buck Ear Curette, 5 3/4", Angled Sharp, Size 2.....	31
Buck Ear Curette, 5 3/4", Angled Sharp, Size 3.....	31
Buck Ear Curette, 5 3/4", Angled Sharp, Size 4.....	31
Buck Ear Curette, 5 3/4", Angled Sharp, Size 5.....	31
Buck Ear Curette, 5 1/2", Straight, Sharp, Size 0.....	31
Buck Ear Curette, 5 1/2", Straight, Sharp, Size 00.....	31
Buck Ear Curette, 5 1/2", Straight, Sharp, Size 1.....	31
Buck Ear Curette, 5 1/2", Straight, Sharp, Size 2.....	31



# INDEX

## C

Canine Mouth Gag Large Size 6 3/4"	16
Canine Mouth Gag Medium Size 5 3/4"	16
Canine Mouth Gag Small Size 4"	16
Canine/Feline Spay Pack	73
Cannulated Pin and Wire Cutter 7 1/2"	58
Carmalt (Splinter) Forceps, Curved, 4 3/4"	34
Carmalt (Splinter) Forceps, Straight, 4 3/4"	34
Cast Spreader Walton 9"	81
Castroviejo Eye Speculum 3 3/4"	52
Castroviejo Needle Holder, 5 1/2", Straight Without Catch	45
Castroviejo Needle Holder, 5 1/4", Curved Jaw With Catch	45
Castroviejo Needle Holder, Straight, Smooth with Lock 5 1/2"	45
Castroviejo Needle Holder, Straight, Smooth with Lock,, 5 1/2"	45
Castroviejo Needle Holders, Without Lock, Curved, 5 1/2"	45
Castroviejo Suturing Forceps, Curved, 0tying platform, 4 1/4"	34
Castroviejo Suturing Forceps, Straight, 4 1/4"	34
C-n-S- front side Pin and Wire Cutter TC Insert 7"	58
C-N-S- Pin and Wire Cutter TC Insert	58
Collier Needle Holder 5"	44
Cooley Vascular Tissue Forceps, tips 2mm wide, 6"	3
Cooley Vascular Tissue Forceps, tips 2mm wide, 8"	3
Crile Hemostatic Forceps Curved 5 1/2"	36
Crile Hemostatic Forceps Straight 5 1/2"	36
Crile-Rankin Hemostatic Forceps, Curved, 6 1/4"	36
Crile-Rankin Hemostatic Forceps, Straight, 6 1/4"	36
Crile-Wood Needle Holder, Tungsten Carbide, 10"	48
Crile-Wood Needle Holder, Tungsten Carbide, 12"	48
Crile-Wood Needle Holder, Tungsten Carbide, 7"	48
Crile-Wood Needle Holder, Tungsten Carbide, 8"	48
Crile-Wood Needle Holder, Tungsten Carbide, 9"	48
Crile-Wood Needle Holder, Standard 6"	48
Cruciate Needle Holder, Tungsten Carbide Jaws, 7"	48
CruciatePacks	74
Cruciate Repair Crimping Forceps	56
Curette Columbia 13-14 Fine TTDE, Double Ended	20
Curette Columbia 4L-4R TTDE, Double Ended	20
Curette Style H6/7	21

## D

Dandy Nerve Hook 9"	56
Davis Stifle Retractor 7" With Speed Lock, Cross Action Tips	83
Dean Rongeur 3mm x 10mm Bite Curved, 5 3/4"	85
Debakey Adson Tissue Forceps, 4 3/4", 1.5 mm tips	3
Debakey Thoracic Tissue Forceps, 2.5mm wide Tips, 6"	3
Debakey Tissue Forceps, Atraumatic Jaws, 2.0mm, 6.25"	3
Debakey Tissue Forceps, Atraumatic Jaws, 2.0mm, 7.75"	3
Debakey Tissue Forceps, Atraumatic Jaws, 2.0mm, 9.5"	3
Debakey Tissue Forceps, Atraumatic Jaws, 3.5mm, 6.25"	3
Debakey Tissue Forceps, Atraumatic Jaws, 3.5mm, 7.75"	3
Debakey Tissue Forceps, Atraumatic Jaws, 3.5mm, 9 1/2"	3
Debakey Vascular Clamp for Aortic Aneurism, slightly curved	4
Debakey Vascular Clamp for Aortic Aneurism, 12 cm, Size 12 3/4"	4
Debakey Vascular Clamp for Aortic Aneurism, Size 10"	4
Debakey Vascular Clamp for Aortic Aneurism, slightly 10 1/2"	4
Debakey Vascular Tissue Forceps, 1.5mm wide Tips, 6"	4
Debakey Vascular Tissue Forceps, 1.5mm wide Tips, 8"	4
Debakey Vascular Tissue Forceps, 1.5mm wide Tips, 9 1/2"	4
Deluxe Mirror Handle Cone Socket	18

Dental Explorer 2D	11
Dental Explorer and Graduated Probe, D/E style PE1-23	11
Dental Explorer, 17	12
Dental Explorer, Style 7	12
Dental Explorer, style 3A	12
Dental Extracting Forceps Universal, Witzel, DEF116	8
Dental Extracting Forceps Universal, Witzel, DEF120	8
Dental Extracting Forceps, 1st and 2nd Molar, Left, 18L	8
Dental Extracting Forceps, A, Pedo Upper Molar, Universal, Mini	8
Dental Extracting Forceps, B, Pedo Lower Root, Universal, Mini	9
Dental Extracting Forceps, E, Pedo Upper Front, Mini	9
Dental Extracting Forceps, F, Pedo Upper Root, Universal, Mini	9
Dental Extracting Forceps, Lower Incisors, Roots, Universal, 151	9
Dental Extracting Forceps, Upper and Lower Universal, 101	9
Dental Extracting Forceps, Upper and Lower Fragments and Roots	9
Dental Extracting Forceps, Upper and Lower 6	10
Dental Extracting Forceps, Upper Anteriors, Split Beaks	10
Dental Extracting Forceps, Upper Bicuspid, Incisors and Roots, 286	10
Dental Extracting Forceps, Upper Incisors, Cuspids, Universal, 150	10
Dental Extracting Forceps, Upper Incisors, Henahan, 1HEN	10
Dental Extracting Forceps, C, Pedo Lower Molars, Universal, Mini	10
Dental Laryngeal Mirror Size 0, 12mm	17
Dental Laryngeal Mirror Size 1, 14mm	17
Dental Laryngeal Mirror Size 2, 16mm	17
Dental Laryngeal Mirror Size 3, 18mm	17
Dental Laryngeal Mirror Size 4, 20mm	17
Dental Laryngeal Mirror Size 5, 22mm	17
Dental Laryngeal Mirror Size 6, 26mm	17
Dental Standard Extracting Forceps #62	11
Depth Gauge, Mini Screw	42
Depth Gauge, Regular	42
Derf Needle Holder 4 3/4" Serrated	48
Derf Needle Holder, Serrated, 4 3/4", Tungsten Carbide	48
Desmarres Chalazion Forceps, 16mm, 3 1/2"	53
Desmarres Chalazion Forceps, 20mm Diameter, 3 1/2"	53
Desmarres Chalazion Forceps, 25mm Diameter, 3 1/2"	53
Desmarres Chalazion Forceps, 30mm Diameter, 3 1/2"	53
Diamond Pin and Wire cutter 6 1/2"	58
Disposable Scalpel, Stainless Steel Blade, Plastic Handle, Size 12	101
Disposable Scalpels, Stainless Steel Blade, Plastic Handle, Size 21	101
Double Action Pin Cutter 15"	58
Doyen Abdominal Scissors, 7" curved	87
Doyen Abdominal Scissors, 7" straight	87
Doyen Intestinal Forceps Curved 9"	34
Doyen Intestinal Forceps Straight 9"	34
Duckbilled Mini-Rongeur 5"	59

## E

Echlin Rongeur (Duckbill) 9" Angular 2x15mm Bite	59
Echlin Rongeur (Duckbill) 9" Angular 3x15mm Bite	59
Echlin Rongeur (Duckbill) 9" Angular 4x15mm Bite	59
Economy Utility Scissors, Serrated, 5 1/2"	62
Economy Utility Scissors, Serrated, 7 1/2"	62
Elevator, Periosteal, Molt, DEL M9	12
Emergency Room Shears, 8 1/2" serrated edge	87
Engel Cast Cutter 6"	68

Eppendorfer-Krause Rotating Shaft Biopsy Forceps, Size 9",.....	68
Excavator Style #33L.....	12
Excavator Style #38/39.....	12
Excavator Style #61/62.....	13
Excision Arthroplasty Rasp 170mm.....	70
Eye Dressing Forceps Straight, Serrated Tips, 4".....	26
Eye Dressing Forceps, 4" Half-Curved Tips, Heavy Pattern.....	26
Eye Dressing Forceps, 4" Heavy Pattern.....	26
Eye Dressing Forceps, 4" Serrated, Straight Tips.....	26
Eye Dressing Forceps, Full Curved, Serrated Tips, 4".....	26
Eye Dressing Forceps, Half Curved, Serrated Tips, 4".....	26
Eye Suture Scissors, Curved Pointed Blades 3 3/4".....	53

## F

Feline Bandage Scissors, 7".....	92
Feline Mouth Gag Light Weight 3".....	16
Feline Petite Mouth Gag light Weight 2 1/4".....	16
Ferguson Angiotribe Forceps Curved 6 1/2".....	36
Ferguson Angiotribe Forceps Curved 7 1/2".....	36
Ferguson Angiotribe Forceps Straight 6 1/2".....	36
Ferguson Angiotribe Forceps Straight 7 1/2".....	36
Ferguson Gall Stone Scoop Double Ended, Small, 9 1/2".....	56
Ferguson Gall Stone Scoop Double Ended, Large, 9 1/2".....	56
Ferguson Gall Stone Scoop Double Ended, Medium, 9 1/2".....	56
Ferguson-Frazier Suction Tubes, 10 French.....	32
Ferguson-Frazier Suction Tubes, 11 French.....	32
Ferguson-Frazier Suction Tubes, 12 French.....	32
Ferguson-Frazier Suction Tubes, 14 French.....	32
Ferguson-Frazier Suction Tubes, 6 French.....	32
Ferguson-Frazier Suction Tubes, 7 French.....	32
Ferguson-Frazier Suction Tubes, 8 French.....	32
Ferguson-Frazier Suction Tubes, 9 French.....	32
Ferris Smith Rongeur 7" 4mmx10mm Up Angle.....	85
Ferris Smith Rongeur 7" 6mmx10mm Down Angle.....	85
Ferris Smith Rongeur 7" 6mmx10mm Straight.....	85
Ferris Smith Rongeur 7" 6mmx10mm Up Angle.....	85
Ferris Smith Rongeur 7" 6mmx12mm Straight.....	85
Ferris Smith Tissue Forceps, 2x3 Teeth, 6 3/4".....	26
Finger Ring Cutter Blade.....	43
Finger Ring Cutter With Blade.....	43
Finochietto Rib Spreader, Original Model, Standard Size,12".....	81
Finochietto Rib Spreader, Original Model, Standard Size.....	81
Finochietto Rib Spreader, Original Model, Standard Size.....	81
Finochietto Thoracic Forceps and Ligature Carrier 9 1/2".....	110
Finochietto Thoracic Forceps, slightly curved jaws, 9".....	110
Foerster Sponge Forceps, Serrated Jaws Curved, 7".....	111
Foerster Sponge Forceps, Serrated Jaws Curved, 9 1/2".....	111
Foerster Sponge Forceps, Serrated Jaws Straight, 7".....	111
Foerster Sponge Forceps, Serrated Jaws Straight, 9 1/2".....	111
Fomon Rasp, Coarse Teeth 8 1/4".....	71
Fomon Rasp, Fine Teeth 8 1/4".....	71
Fomon Rasp, Sided Teeth 8 1/4".....	71
For measuring and marking, 3 1/4", 8.5 cm.....	42
Freer Elevators, Double Ended With Blunt/sharp Blades, 7", 5mm.....	57
Friedman Dental Rongeur 5 1/2", Curved & Delicate.....	13
Fulton Laminectomy Rongeur, slightly curved jaws, 7 x 18 mm.....	50
Fulton Laminectomy Rongeur, Straight jaws, 7 x 18 mm, Size 9 1/2".....	50

## G

Gelpi Retractor 3 1/2".....	82
Gelpi Retractor 4 1/2".....	82
Gelpi Retractor 4 1/2" Right Angled.....	82
Gelpi Retractor 5 1/4".....	82
Gelpi Retractor 7".....	82
Gelpi Retractor Right Angled 5 1/2".....	82
Gelpi Retractor With Grip Lock 6 3/4".....	82
Gemini-Mixer, Delicate, Full Curved Jaws, 5 1/2".....	35
Gemini-Mixer, Delicate, Full Curved Jaws, 7".....	35
Gemini-Mixer, Delicate, Full Curved Jaws, 8".....	35

Gemini-Mixer, Delicate, Full Curved Jaws, 9".....	35
German Advanced Eye Pack.....	74
German Starter Eye Pack.....	75
Gerzog Mallet 7 1/2" 100Z.....	63
Gerzog Mallet 7" 16oz.....	63
Gerzog Mallet, 7 1/2" 7oz.....	63
Gigli Saw 12", Standard twisted wire type.....	51
Gigli Saw 20", Standard twisted wire type.....	51
Gigli Saw 30", Standard twisted wire type.....	51
Gigli Saw Handle, T-Shape turnable, Standard 2 1/2".....	51
Gigli-Strully Saw Handle, T-Shape,Rigid with snap lock, Standard.....	51
Gillies Hook, Small 8".....	67
Goldman Fox Scissors, Curved 5", SUPERCUT.....	98
Goldman Fox, Curved 5", Tungsten Carbide.....	97
Goldstein Eye Retractor, 3x3 pointed prongs, 5mm Deep 1 1/8".....	82
Goniometer Polk Finger 6" Graduated cm/inch.....	42
Gossett Abdominal Retractor, 5.5".....	82
Gracey Curettes 11/12, Double Ended.....	20
Gracey Curettes 11/14.....	21
Gracey Curettes 12/13.....	21
Gracey Curettes 13/14, Double Ended.....	20
Gracey Curettes 15/16.....	21
Gracey Curettes 17/18.....	21
Gracey Curettes 3/4, Double Ended.....	21
Gracey Curettes 5/6, Double Ended.....	21
Gracey Curettes 9/10, Double Ended.....	20
Gracey Curettes G 1/2, Double Ended.....	21
Gradle Scissors Curved 3 3/4".....	91
Gradle Scissors, Curved 3 3/4", SUPERCUT.....	99
Graduated Probe, Style "C".....	79
Graefe Eye Speculum 3 1/2".....	52
Graefe Fixation Forceps 4 3/8", Without Catch.....	54
Graefe Fixation Forceps 4 3/8" Non magnetic without catch.....	54
Graft Curved Passer, 2.0cm.....	60
Graft Curved Passer, 3cm.....	60
Graft Curved Passer, 4.5cm.....	60
Graft Curved Passer, Extra Large.....	60
Graft Curved Passer, xx-Large.....	60
Grooved Director 4 1/2".....	79
Grooved Director 5 1/2".....	79
Grooved Director 5".....	79
Grooved Director 6".....	79
Gruenwald Nasal Punch 4 1/2" Shaft, 2 x 10mm Bite.....	43
Gruenwald Nasal Punch 4 1/2" Shaft, 2.5 x 12mm Bite.....	43
Gruenwald Nasal Punch, 4 1/2" Shaft, 3 X 12mm Bite.....	43

## H

Halsey Needle Holder, Serrated Jaws, 5",.....	47
Halsey Needle Holder, Smooth Jaws, 5",.....	47
Halsey Needle Holder, Tungsten Carbide, Serrated Jaw, 5".....	47
Halsey Needle Holder, Tungsten Carbide, Smooth Jaw, 5".....	47
Halstead Mosquito Forceps Curved 5".....	37
Halstead Mosquito Forceps Straight 5".....	37
Halstead Mosquito Forceps, Curved 1x2 Teeth, 5".....	37
Halstead Mosquito Forceps, extra delicate, Curved, Size 5".....	37
Halstead Mosquito Forceps, extra delicate, Straight, Size 5".....	37
Halstead Mosquito Forceps, Straight 1x2 Teeth, 5".....	37
Hartman Alligator Forceps.....	32
Hartman Alligator Forceps.....	32
Hartman Alligator Forceps.....	32
Hartman Alligator Forceps 1 x 2 Teeth.....	32
Hartman Alligator Forceps Round Cup Jaws, 2 1/2".....	32
Hartman Mosquito Forceps, Curved Standard Pattern, 3 1/2".....	36
Hartman Mosquito Forceps, Straight Standard Pattern, 3 1/2".....	36
Hartman Rongeur, Curved 4x12mm bite, Size 5 3/4".....	33
Hartman-Noyes Ear Forceps, Alligator Type, Serr, 3" Shaft.....	44

Heaney Needle Holder Curved, 10".....	47
Heaney Needle Holder Curved, 8 1/4".....	47
Heaney Needle Holder, Tungsten Carbide, Curved, 10".....	47
Heavy Duty Cruciate Needle Driver, Tungsten Carbide.....	106
Heidbrink Root Tip Pick, Del H1, Delicate, Straight, 5 1/4".....	5
Heidbrink Root Tip Pick, Del H2-3, Delicate, Double Ended, 7 3/4".....	5
Heidbrink Root Tip Pick, Del H3, Delicate, Left, 5 1/4".....	5
Heidbrink Root Tip Pick, Del H3, Delicate, Right, 5 1/4".....	5
Hi-Level Bandage Scissors, Angled 5 1/2".....	92
Hirschfeld File, 3-7.....	13
Hirschfeld File, 5-11.....	13
Hirschfeld File, 9-10.....	13
Hoff Non Perforated Towel Clamp 5 1/4".....	111
Hohmann Retractor 10mm wide, 9 1/4"/ 23 Cm.....	57
Hohmann Retractor, 12 mm Width, 8".....	57
Hohmann Retractor, 18 mm Width, 9".....	57
Hohmann Retractor, 22mm Wide Blade.....	57
Hohmann Retractor, 43mm Wide Blade.....	57
Hohmann Retractor, 70mm Wide Blade.....	57
Hoke Osteotomes, 5 1/2",Straight, 1/2".....	61
Hoke Osteotomes, 5 1/2",Straight, 1/4".....	61
Hoke Osteotomes, 5 1/2",Straight, 1/8".....	61
Hoke Osteotomes, 5 1/2",Straight, 3/16".....	61
Hoke Osteotomes, 5 1/2",Straight, 3/8".....	61
Hoke Osteotomes, 5 1/2",Straight, 5/16".....	61
Holzheimer Retractor 4" 4x4 Prongs Blunt.....	82
Holzheimer Retractor 4" 4x4 Prongs Sharp.....	82
Hudson Brace, Large.....	83
Hudson Brace, Small.....	83

<b>I</b>	
Inge Retractor, 11".....	83
Inge Retractor, 6 1/2".....	83
Iris Scissors Curved 3 1/2".....	93
Iris Scissors Curved 4 1/2" With Sharp Tips.....	93
Iris Scissors Str 4 1/2" With Sharp Tips.....	93
Iris Scissors Straight 3 1/2".....	93
Iris Scissors, 3 1/2" Curved, With Sharp Tips.....	93
Iris Scissors, 3 1/2" Straight, With Sharp Tips.....	93
Iris Scissors, Curved 4" Sharp Points.....	93
Iris Scissors, Curved Supercut, 4 1/2".....	99
Iris Scissors, Curved Tungsten Carbide, 4 1/2".....	89
Iris Scissors, Straight 4" Sharp Points.....	93
Iris Scissors, Straight Supercut, 4 1/2".....	99
Iris Scissors, Straight Tungsten Carbide, 4 1/2".....	89
Iris Scissors, Tungsten Carbide Inserts, Curved, 4 1/2"/ 11.5 cm.....	98
Iris Scissors, Tungsten Carbide Inserts, Straight, 4 1/2"/ 11.5 cm.....	98
Iris Tissue Forceps 1/2 Curved.....	27
Iris Tissue Forceps 4" 1x2 teeth.....	27
Iris Tissue Forceps 4", 1x2th, Full Curved.....	27

<b>J</b>	
Jacobson Micro Mosquito Forceps, Curved, Size 5".....	36
Jacobson Micro Mosquito Forceps, Curved, Size 7".....	36
Jacobson Micro Mosquito Forceps, Straight Size 7".....	36
Jacobson Micro Mosquito Forceps, Straight, Size 5".....	36
Jacquette Scaler, 20/33.....	18
Jacquette Scaler, 33/H5.....	18
Jacquette Scaler, Double Ended, 1Y/1Y.....	18
Jacquette Scaler, Double Ended, 2/3.....	18
Jacquette Scaler, Double Ended, 2S/3S.....	19
Jacquette Scaler, Double Ended, 2Y/3Y.....	19
Jacquette Scaler, Single Ended, U-15.....	19
Jansen Bayonet Forceps, Serrated, 7 1/2".....	54
Jeweler's Forceps # 7 Swiss Style, Extra Fine Tips, Curved, 4 1/2".....	53

Jeweler's Forceps, # 5 Swiss Style, Fine Points, Angled, 4 1/2".....	53
Jeweler's Tweezers, #5 Superfine Point, 4 3/4".....	54
Jones Towel Clamp, 3".....	111
Jones Towel Clamp, Light Weight 2 1/4".....	111
Joseph Hook Double Prong, 5mm Wide, 6".....	67
Joseph Hook, Double Prong, 2mm Wide, 6".....	67
Joseph Hook, Sharp Single Prong, 6".....	67

<b>K</b>	
Keith Abdominal Surgical Needle, Straight Triangular Point.....	106
Kelly Hemostatic Forceps Curved 5 1/2".....	37
Kelly Hemostatic Forceps Straight 5 1/2".....	37
Kern Bone Holding Forceps 9 1/2" With Ratchet.....	65
Kern Bone Holding Forceps 9 1/2" Without Ratchet.....	65
Kerrison Rongeur 7" 1mm Down-Bite 40 Degree.....	85
Kerrison Rongeur 7" 1mm Up-Bite 90 Degree.....	85
Kerrison Rongeur 7" 2mm Up-Bite 90 Degree.....	85
Kerrison Rongeur 7" 3mm Up-Bite Thin Foot Plate 40 Degree.....	85
Key Elevator, 7 1/2", Squared .25".....	70
Key Elevator, 7 1/2", Squared .5".....	70
Key Elevator, 8 1/4", Squared 1.0".....	70
Key Elevator, 8", Squared .75".....	70
Keyes Cutaneous Punch, 2 mm Tip, 4" (10cm).....	61
Keyes Cutaneous Punch, 3 mm Tip, 4" (10cm).....	61
Keyes Cutaneous Punch, 4 mm Tip, 4" (10cm).....	61
Keyes Cutaneous Punch, 6 mm Tip, 4" (10cm).....	61
Keyes Cutaneous Punch, 8 mm Tip, 4" (10cm).....	61
Killian Canine Speculum 2".....	101
Killian Canine Speculum 3 1/2".....	101
Killian Canine Speculum 3".....	101
Kirschner Wires, 12" flat end 1.6mm.....	68
Kirschner Wires/ w/flat end 0.9MM 12".....	68
Kirschner Wires/ w/flat end 1.1mm 12".....	68
Knife Handle No. 3, Fits blades 10-15.....	40
Knife Handle No. 3, Graduated in Millimeters.....	40
Knife Handle No. 3L, Long handle for Deep Surgery.....	40
Knife Handle No. 4, Fits Blades, 20- 25.....	40
Knife Handle No. 4, Graduated in Millimeters.....	41
Knife Handle No. 4L, Fits Blades 2025, Long Handle for Deep Surgery.....	41
Knife Handle No. 5, Fits Blades 10-15, Extra Fine, Plastic.....	41
Knife Handle No. 6, Fits Blades 20-25, Extra Fine, Plastic.....	41
Knife Handle No.7.....	41
Knife Handle, Round, Fitting blades 10-15.....	41
Knowles Bandage Scissors, Straight 5 1/2".....	91
K-wire Small Pin Punch.....	61
K-wire sutter, TC 2.2MM.....	59
K-wire sutter, TC 2.5MM.....	59

<b>L</b>	
Lahey Retractor 1 Sharp Prong, 4 3/4".....	84
Lahey Retractor 2 Sharp Prongs, 4 3/4".....	84
Lahey Retractor 3 Sharp Prongs, 4 3/4".....	84
Lahey Vulsellum Forceps, 3X3 Teeth, 6 1/4".....	27
Lambert-Lowman Bone Clamp, Bone Clamp 1" Wide.....	64
Lancaster Eye Speculum 2 3/4".....	52
Lane Bone Forceps 13" Standard With Ratchet.....	65
Lane Bone Forceps 13" Standard Without Ratchet.....	65
Lane Bone Holding Forceps, 17" Plain".....	65
Lane Bone Holding Forceps, 17" With Ratchet.....	65
Leksell Rongeur 9" 4x16mm Bite Angled.....	86
Leksell Rongeur 9" 7x16mm Bite Angled.....	86
Lempert Rongeur 2.5mm x 10mm Bite Curved 6 1/2".....	86
Lempert Rongeur 2.5mm x 10mm Bite Straight 6 1/2".....	86
Lewin Bone Holding Forceps 7".....	65
Ligament Meniscus Clamp.....	59
Lister Bandage Scissors 3 1/2".....	92
Lister Bandage Scissors 4 1/2".....	92

Lister Bandage Scissors 5 1/2".....	92
Lister Bandage Scissors 7 1/4".....	92
Lister Bandage Scissors 8" 20.3cm.....	92
Lister Bandage Scissors 8" With One Large Ring. ....	92
Liston Bone Cutting Forceps, Angled, 5 1/2".....	64
Liston Bone Cutting Forceps, Angled, 7 1/2".....	64
Liston Bone Cutting Forceps, Angled, 8 3/4".....	64
Liston Bone Cutting Forceps, Straight, 5 1/2".....	64
Liston Bone Cutting Forceps, Straight, 7 1/2".....	64
Liston Bone Cutting Forceps, Straight, 8 3/4".....	64
Littauer Stitch Scissors, 4 1/2" straight.....	100
Littauer Stitch Scissors, 5 1/2" Straight.....	100
Loopuyt Surgical Needle, Cutting Edge.....	107
Lorna Edna Towel Clamp, Non-Perforating, 5 1/4".....	111
Lorna Non-Perforated Towel Clamp 3 1/2".....	111
Lovelace Lung Grasping Forceps, 7 1/4".....	62
Lovelace Lung Grasping Forceps, Straight serrated jaws 1" wide, 8".....	62
Lucae Forceps, Serrated, 5 1/2".....	62
Lucae Mallet 7 3/4" 7OZ Convex/Flat Head.....	63
Lucae Mallet 8" 8OZ Convex/Flat.....	63
Lucas Bone Curette, No.87.....	19
Lucas Bone Curette, No. 85.....	19
Lucas Bone Curette, No. 86.....	20
Luer Rongeur 8x10mm Bite Curved 7".....	50
Luer Rongeur 8x10mm Bite Straight 7".....	50
Luer Rongeurs, Curved, 7".....	50
Luer Rongeurs, Straight, 7".....	50
Luxating Elevator, Curved Tip 2mm, 5 3/4".....	7
Luxating Elevator, Curved Tip 3mm, 5 3/4".....	7
Luxating Elevator, Curved Tip 4mm, 5 3/4".....	7
Luxating Elevator, Curved Tip 5mm, 5 3/4".....	7
Luxating Elevator, Straight Tip 2mm, 5 3/4".....	7
Luxating Elevator, Straight Tip 3mm, 5 3/4".....	7
Luxating Elevator, Straight Tip 4mm, 5 3/4".....	7
Luxating Elevator, Straight Tip 5mm, 5 3/4".....	7

## M

Mallet Solid Stainless 11" 16oz.....	63
Mallet, lightweight, 7.5 oz, Stainless head, Size 7 1/2".....	63
Mallet, lightweight, 9 oz, Stainless head, Size 7 1/2".....	63
Mathieu Needle Holder, Tungsten Carbide, 5 1/2".....	49
Mathieu Needle Holder, Tungsten Carbide, 6 1/2".....	49
Mayo Common Duct Scoop Large, Malleable, 10 1/2".....	71
Mayo Common Duct Scoop Medium, Malleable, 10 1/2".....	71
Mayo Common Duct Scoop Small, Malleable, 10 1/2".....	71
Mayo Dissecting Scissors 5 1/2" Curved Tungsten Carbide.....	97
Mayo Dissecting Scissors 5 1/2" Straight Tungsten Carbide.....	97
Mayo Dissecting Scissors 6 3/4" Curved Tungsten Carbide.....	97
Mayo Dissecting Scissors 6 3/4" Straight Tungsten Carbide.....	97
Mayo Dissecting Scissors 7" Curved SUPERCUT.....	98
Mayo Dissecting Scissors 9" Straight SUPERCUT.....	98
Mayo Dissecting Scissors Curved 5 1/2".....	87
Mayo Dissecting Scissors Curved 5 1/2" SUPERCUT.....	98
Mayo Dissecting Scissors Curved 6 3/4" SUPERCUT.....	98
Mayo Dissecting Scissors Curved 9".....	87
Mayo Dissecting Scissors Straight 5 1/2".....	87
Mayo Dissecting Scissors Straight 6 3/4".....	87
Mayo Dissecting Scissors Straight, 5 1/2" SUPERCUT.....	98
Mayo Dissecting Scissors Straight, 6 3/4" SUPERCUT.....	98
Mayo Dissecting Scissors, 9" straight.....	87
Mayo Dissecting Scissors, Curved, 6 3/4".....	87
Mayo Dissecting Scissors, Tungsten Carbide Insert, Curved, 9".....	97
Mayo Dissecting Scissors, Tungsten Carbide Insert, Straight, 9".....	97
Mayo Gall Stone Scoop, Double Ended, 11 1/2"/28cm.....	71
Mayo Hegar Needle Holder 5 1/4".....	45
Mayo Hegar Needle Holder 6".....	45
Mayo Hegar Needle Holder 7".....	45
Mayo Hegar Needle Holder 8".....	45

Mayo Hegar Needle Holder, Serrated, 5 1/4", Tungsten.....	45
Mayo Hegar Needle Holder, Tungsten Carbide, 12".....	45
Mayo Hegar Needle Holders, Serrated, 10 1/2", Tungsten.....	45
Mayo Hegar Needle Holders, Serrated, 6", Tungsten.....	45
Mayo Hegar Needle Holders, Serrated, 7", Tungsten.....	45
Mayo Hegar Needle Holders, Serrated, 8", Tungsten.....	45
Mayo Hegar Needle Holders, Serrated, 9", Tungsten.....	45
Mayo Stille Scissors, Tungsten Insert, Curved, 6 3/4".....	97
Mayo Stille Scissors, Tungsten ,Straight, 6 3/4".....	97
McCalls Curette, Style 11/14.....	22
McCalls Curette, Style 17/18.....	22
Mead Mallet 7 1/2".....	63
Meeker Kantrowitz Forceps, Full Curved Jaws, 7 3/4".....	66
Meltzer Adenoids Nasal Punch 5" Shaft, Size 2.....	43
Meniscus Knife 7 1/2".....	57
Metzenbaum Curved 4 1/2" Supercut.....	99
Metzenbaum Dissecting Scissors 8" Delicate.....	93
Metzenbaum Dissecting Scissors Curved 5".....	94
Metzenbaum Dissecting Scissors Curved 7".....	94
Metzenbaum Dissecting Scissors Curved 5 3/4" Supercut.....	99
Metzenbaum Dissecting Scissors Curved 7" Supercut.....	99
Metzenbaum Dissecting Scissors Curved 9"(nelson).....	99
Metzenbaum Dissecting Scissors Straight 7" SUPERCUT.....	99
Metzenbaum Dissecting Scissors Straight 9" SUPERCUT.....	99
Metzenbaum Dissecting Scissors Str 5" Delicate.....	93
Metzenbaum Dissecting Scissors Str 6" Delicate.....	93
Metzenbaum Dissecting Scissors Straight 5".....	94
Metzenbaum Dissecting Scissors, Delicate, 7" straight.....	93
Metzenbaum Dissecting, Delicate, 9" straight.....	93
Metzenbaum Scissors (Lahey), Curved, 5.75",TC.....	95
Metzenbaum Scissors (Lahey), Curved , 5.75",TC.....	95
Metzenbaum Scissors (Lahey), Curved Standard, 5.75",TC.....	95
Metzenbaum Scissors (Lahey), Curved, 5.75", Standard.....	93
Metzenbaum Scissors (Lahey), Pedifine Curved, 4.5",.....	93
Metzenbaum Scissors (Lahey), Straight, 5.75", TC.....	95
Metzenbaum Scissors (Lahey), Straight Standard, 5.75",TC.....	95
Metzenbaum Scissors (Lahey), Straight, 5.75", Standard.....	93
Metzenbaum Scissors (Lahey),Pedifine Straight, 4 1/2".....	93
Metzenbaum Scissors (Lahey),Straight , 5.75",TC.....	95
Metzenbaum Scissors (Nelson), Curved Delicate, 7",TC.....	95
Metzenbaum Scissors (Nelson), Curved Delicate, 9",TC.....	95
Metzenbaum Scissors (Nelson), Curved, 10", Standard.....	94
Metzenbaum Scissors (Nelson), Curved, 11", Standard.....	94
Metzenbaum Scissors (Nelson), Curved, 7", Standard.....	94
Metzenbaum Scissors (Nelson), Curved, 7",TC.....	95
Metzenbaum Scissors (Nelson), Curved, 8", Standard.....	94
Metzenbaum Scissors (Nelson), Curved, 9", Standard.....	94
Metzenbaum Scissors (Nelson), Straight Delicate, 7",TC.....	94
Metzenbaum Scissors (Nelson), Straight Delicate, 9",TC.....	95
Metzenbaum Scissors (Nelson), Straight, 9", Standard.....	94
Metzenbaum Scissors (Nelson), Straight, 9", TC.....	95
Metzenbaum Scissors (Nelson), Straight, 10", Standard.....	94
Metzenbaum Scissors (Nelson), Straight, 11", Standard.....	94
Metzenbaum Scissors (Nelson), Straight, 7",TC.....	95
Metzenbaum Scissors (Nelson), Straight, 8", Standard.....	94
Metzenbaum Scissors 5 1/2" Curved Supercut.....	99
Metzenbaum Scissors 5 1/2" Straight, Standard.....	94
Metzenbaum Scissors 5 1/2" Straight, Supercut.....	99
Metzenbaum Scissors 5" Curved, Supercut.....	99
Metzenbaum Scissors 7" Curved,Supercut.....	99
Metzenbaum Scissors Curved 8".....	94
Metzenbaum Scissors Straight 7".....	94
Metzenbaum Scissors TC Insert,, curved, 5 1/2"/ 14.5 cm.....	96
Metzenbaum Scissors TC, Standard, Curved, 7"/ 17.5 cm.....	96
Metzenbaum Scissors TC Insert, , Curved, 8"/ 20 cm.....	96
Metzenbaum Scissors, Supercut, Straight, 5 1/2".....	99
Metzenbaum Scissors, Supercut, Straight, 7".....	99

Metzenbaum Scissors, TC, Delicate,Curved, 5 1/2".....	96
Metzenbaum Scissors, TC Insert, Delicate,Curved, 7".....	96
Metzenbaum Scissors, TC Insert, Delicate,Curved, 9".....	96
Metzenbaum Scissors, TC Insert, Delicate,Straight, 5 1/2".....	96
Metzenbaum Scissors, TC Insert, Delicate,Straight, 7" 17.5 cm.....	96
Metzenbaum Scissors, TC Insert, Delicate,Straight, 9"/ 22.5m.....	96
Metzenbaum Scissors, TC Insert, Standard, Curved, 11"/ 27.5 c.....	96
Metzenbaum Scissors, TC Insert, Standard, Straight, 7"/ 17.5 cm.....	96
Metzenbaum Scissors, TC Insert, Standard, Straight, 8"/ 20 cm.....	96
Metzenbaum Scissors, TC Insert, Standard, Straight, 9"/ 22.5 cm.....	96
Metzenbaum Straight 4 1/2" Supercut.....	99
Metzenbum Scissors Curved 9".....	94
Metzenbum Scissors Straight 14 1/2".....	94
Metzenbum Scissors Straight 9".....	94
Meyerding Retractor, 52mmX16mm Blade, Small, 10".....	83
Meyerding Retractor, 75mmX25mm Blade, Medium, 10".....	83
Meyerding Retractor, 89mm X 50mm Blade, Large, 10".....	83
Michele Trepine, 6 1/4" graduated.....	51
Michele Trepine, 6 1/4" shaft.....	51
Michele Trepine, Marker .....	51
Micro Friedman Ronguers, Curved Jaws, angled 15 Degrees, 5 1/2"....	86
Micro Friedman Ronguers, Curved Jaws, 90 Degrees, 5 1/2".....	86
Micro Mosquito Forceps, Curved, Very Delicate Pattern, 4 3/4".....	66
Micro Mosquito Forceps, Straight, Very Delicate Pattern, 4 3/4".....	66
Micro Surgery Needle Holder 5 1/4", Curved Jaws.....	47
Micro Surgery Needle Holder 7 1/8", Curved Jaws.....	47
Micro Surgery Needle Holder 7 1/8", Straight Jaws.....	47
Micro Surgery Needle Holder, 5 1/4.....	47
Micro Surgery Needle Holder, 7 1/8", Curved Jaws With Lock.....	47
Micro Surgery Needle Holder, 7 1/8", Straight Jaws With Lock.....	47
Microsurgical (Beaver) Blade Handle 4" in Length.....	41
Microsurgical (Beaver) Blade Handle 5" in Length.....	41
Mini Lambotte Osteotome 5" Straight 10mm.....	60
Mini Lambotte Osteotome 5" Straight 2mm.....	60
Mini Lambotte Osteotome 5" Straight 4mm.....	60
Mini Lambotte Osteotome 5" Straight 6mm.....	60
Mini Lambotte Osteotome 5" Straight 8mm.....	60
Mini-Hohman Retractor 6 1/4".....	57
Mini-Hohman Retractor 6 1/4".....	57
Mirror Handle Cone Socket/Mirror #4.....	16
Modified Gigli Bone Saw Wire, Loop Grip.....	51
Modified Gigli Bone Saw Wire, Turnable.....	51
Modified Stifle Retractor 18cm.....	83
Morse Scaler 0-00.....	19

## N

Neoprene Cord 32" For Tourniquet 6 1/4".....	42
Northbent Stitch Scissors 3 1/2".....	100
Northbent Stitch Scissors, Curved Sideways, 4 1/2".....	100
Noyes Alligator Forceps, Serrated Shaft, 5 1/2".....	44
Noyes Alligator Forceps, Serrated Shaft, 6 1/2".....	44

## O

Ochsenbein Chisel #1.....	13
Ochsenbein Chisel #2.....	13
Ochsenbein Chisel 4.....	13
Octagonal Mirror Handle, Cone socket.....	18
Olsen-Hegar Combined Ndl Hldr and Scrs, Delicate, 4 3/4", TC.....	46
Olsen-Hegar Combined Needle Holder & Scissors 5 1/2".....	46
Olsen-Hegar Combined Needle Holder & Scissors 6 1/2".....	46
Olsen-Hegar Combined Needle Holder & Scissors 7 1/4".....	46
Olsen-Hegar Combined Needle Holder and Scissors, 6 1/4",TC.....	46
Olsen-Hegar Needle Holder, European Pattern, 6 1/2".....	46
Olsen-Hegar Needle Holder, Tungsten Carbide, 5 1/2".....	46
Olsen-Hegar Needle Holder, Tungsten Carbide, 7 1/2".....	46

Operating Scissors Standard pattern straight, Sharp/Sharp, 4 1/2".....	88
Operating Scissors Standard pattern, curved, Sharp/ Blunt, 6".....	88
Operating Scissors Standard pattern, curved, Sharp/Blunt, 4 1/2".....	88
Operating Scissors Standard pattern, curved, Sharp/Blunt, 5 1/2".....	88
Operating Scissors Standard pattern, curved, Sharp/Blunt, 5".....	88
Operating Scissors Standard pattern, curved, Sharp/Blunt, 6 1/2".....	88
Operating Scissors Standard pattern, curved, Sharp/Blunt, 7 1/2".....	88
Operating Scissors Standard pattern, curved, Sharp/Sharp, 4 1/2".....	89
Operating Scissors Standard pattern, curved, Sharp/Sharp, 5 1/2".....	89
Operating Scissors Standard pattern, curved, Sharp/Sharp, 5".....	89
Operating Scissors Standard pattern, curved, Sharp/Sharp, 6 1/ 2".....	89
Operating Scissors Standard pattern, curved, Sharp/Sharp, 6".....	89
Operating Scissors Standard Pattern, sharp/sharp, Curved 5 1/2", SC....	91
Operating Scissors Standard Pattern, sharp/sharp, Straight 5 1/2", SC..	91
Operating Scissors Standard pattern, straight, 5" Sharp/Sharp.....	88
Operating Scissors Standard pattern, straight, 6".....	89
Operating Scissors Standard pattern, straight, Blunt/Blunt, 4 1/2".....	90
Operating Scissors Standard pattern, straight, Blunt/Blunt, 5 1/2".....	90
Operating Scissors Standard pattern, straight, Blunt/Blunt, 5 1/2", SC..	91
Operating Scissors Standard pattern, straight, Blunt/Blunt, 5".....	90
Operating Scissors Standard pattern, straight, Blunt/Blunt, 6 1/2".....	90
Operating Scissors Standard pattern, straight, Blunt/Blunt, 6".....	90
Operating Scissors Standard pattern, straight, Sharp/Blunt 4 1/2".....	89
Operating Scissors Standard pattern, Straight, Sharp/Blunt, 5 1/2".....	89
Operating Scissors Standard pattern, Straight, Sharp/Blunt, 5 1/2", SC..	91
Operating Scissors Standard pattern, straight, Sharp/Blunt, 5".....	89
Operating Scissors Standard pattern, straight, Sharp/Blunt, 7 1/2".....	89
Operating Scissors Standard pattern, straight, Sharp/Sharp, 6 1/2".....	88
Operating Scissors Standard pattern, straight, Sharp/Sharp, 6".....	88
Operating Scissors Standared pattern, straight, Sharp/Blunt 6 1/2".....	89
Operating Scissors, Curved Blunt/Blunt, 6 1/2".....	90
Operating Scissors, Curved, Blunt/Blunt, 6".....	90
Operating Scissors, Standard pattern, curved, Blunt/Blunt 5".....	90
Operating Scissors, Standard pattern, curved, Blunt/Blunt, 4 1/2".....	90
Operating Scissors, Standard pattern, curved, Blunt/Blunt, 5 1/2".....	90
Operating Scissors, Straight, Blunt/Blunt Tungsten Carbide 5 1/2".....	97
Operating Scissors, Straight, Sharp/Blunt Tungsten Carbide 5 1/2".....	97
Operating Scissors, Straight, Sharp/Sharp Tungsten Carbide 5 1/2".....	97
Operating Scissors,TC Insert,curved, blunt/blunt, 5 1/2".....	97
Operating Scissors,TC Insert,curved, sharp/blunt, 5 1/2".....	97
Operating Scissors,TC Insert,curved, sharp/sharp, 5 1/2".....	97
Orban Knife 1-2.....	20

## P

Parallel Action Wire Cutters.....	64
Parallel Action Wire Cutters 4 1/2".....	64
Pedatric Balfour Abdominal Retractors With Fenestrated.....	81
Pedifine Allis Tissue Forceps, 4X5 Teeth, 4 3/4".....	27
Pedifine Allis Tissue Forceps, 4X5 Teeth, 5 3/4".....	27
Peers Towel Clamp, Non-Perforating, 5.5".....	37
Pin Cutter 19".....	58
Plain (Splinter) Forceps, 3 1/2".....	27
Plain (Splinter) Forceps, 4 1/2".....	27
Plain Wire Speculum, 15mm Wide Blades 2 1/2".....	53
Plate Bender Pliers.....	64
Poole Suction Tube 23 Fr.Curved.....	32
Poole Suction Tube 30 Fr.Straight.....	32
Potts-Smith Dressing Forceps, Serrated Jaw, 6".....	28
Potts-Smith Dressing Forceps, Serrated Jaw, 7".....	28
Potts-Smith Dressing Forceps, Serrated Jaw, 8 1/4".....	28
Potts-Smith Dressing Forceps, Serrated Jaw, 9 1/2".....	28
Potts-Smith Tissue Forceps, 1X2 Teeth, 6".....	28
Potts-Smith Tissue Forceps, 1X2 Teeth, 7".....	28
Potts-Smith Tissue Forceps, 1X2 Teeth, 8 1/4".....	28
Potts-Smith Tissue Forceps, 1X2 Teeth, 9 1/2".....	28
Probe 20-23 Explorer TT DE.....	13

Probe with Eye 10".....	78
Probe with Eye 12".....	78
Probe with Eye 4 1/2".....	78
Probe with Eye 5 1/2".....	78
Probe with Eye 5".....	78
Probe with Eye 6".....	78
Probe with Eye 8".....	78
Probe/Explorer, Double Ended, 3, 6, 9, & 12mm markings.....	79
Providence Hospital Hemostatic Forceps Curved 5 1/2".....	38
Providence Hospital Hemostatic Forceps Straight 5 1/2".....	38
Pynchon Suction Tube 10" tip with large opening.....	32
Pynchon Suction Tube 11" tip with large opening.....	32

## Q

Quick Lock Tourniquet with 32" Neoprene cord.....	42
---	----

## R

Ragnell Dissecting Scissors Flat tip Curved 7" SUPERCUT.....	88
Ragnell Dissecting Scissors Straight 5" Supercut.....	88
Ragnell Retractor 6" D/E.....	83
Rankin-Kelly Forceps Curved 6 1/4".....	38
Rankin-Kelly Forceps Straight 6 1/4".....	38
Ribbon Retractor, Malleable .75", 13".....	84
Ribbon Retractor, Malleable 1.0", 13".....	84
Ribbon Retractor, Malleable 1.25", 13".....	84
Ribbon Retractor, Malleable 1.5", 13".....	84
Ribbon Retractor, Malleable 2.0", 13".....	84
Ribbon Retractor, Malleable 2.5", 13".....	84
Ribbon Retractor, Malleable 3.0", 13".....	84
Rochester-Carmalt Forceps 6 1/4" Curved.....	38
Rochester-Carmalt Forceps 6 1/4" Straight.....	38
Rochester-Carmalt Forceps 8" Curved.....	38
Rochester-Carmalt Forceps 8" Straight.....	38
Rochester-Ochsner (Kocher) Forceps, Curved, 1x2 Teeth, 10".....	39
Rochester-Ochsner (Kocher) Forceps, Curved, 1x2 Teeth, 5 1/2".....	38
Rochester-Ochsner (Kocher) Forceps, Curved, 1x2 Teeth, 9".....	39
Rochester-Ochsner (Kocher) Forceps, Straight, 1x2 Teeth, 10".....	39
Rochester-Ochsner (Kocher) Forceps, Straight, 1x2 Teeth, 5 1/2".....	38
Rochester-Ochsner (Kocher) Forceps, Straight, 1x2 Teeth, 9".....	39
Rochester-Ochsner Forceps Curved 6 1/4" 1x2th.....	40
Rochester-Ochsner Forceps Curved 7 1/4" 1x2th.....	40
Rochester-Ochsner Forceps Curved 8" 1x2th.....	40
Rochester-Ochsner Forceps Straight 7 1/4" 1x2th.....	40
Rochester-Ochsner Forceps Straight 7 1/4" 1x2th.....	40
Rochester-Ochsner Forceps Straight 8" 1x2th.....	40
Rochester-Pean Forceps, Curved, 6 1/4".....	39
Rochester-Pean Forceps, Curved, 7 1/4".....	39
Rochester-Pean Forceps, Curved, 10".....	39
Rochester-Pean Forceps, Curved, 8".....	39
Rochester-Pean Forceps, Curved, 9".....	39
Rochester-Pean Forceps, Straight, 10".....	39
Rochester-Pean Forceps, Straight, 6 1/4".....	39
Rochester-Pean Forceps, Straight, 7 1/4".....	39
Rochester-Pean Forceps, Straight, 8".....	39
Rochester-Pean Forceps, Straight, 9".....	39
Roeder Towel Clamp 5 1/4".....	37
Roger Wire Cutting Scissors, Serrated Angular, 4 3/4".....	100
Roger Wire Cutting Scissors, Serrated Angular, 4 3/4",TC.....	100
Root Elevator, Crane Pick, DEL 34.....	5
Root Elevator, Crane Pick, DEL 34S.....	5
Root Elevator, Crane Pick, DEL46 Elevator.....	5
Root Elevators, Apical, DEL 301.....	5
Root Elevators, Apical, DEL 302HF.....	6
Root Elevators, DEL 78.....	6
Root Tip Elevator, Del 79, Curved Right, 5 1/2".....	6
Root Tip Elevator, Del 80, Curved Left, 5 1/2".....	6
Ruskin Bone Cutting Forceps Angled Jaw 7 1/4".....	65

Ruskin Bone Cutting Forceps Curved 6".....	65
Ruskin Bone Cutting Forceps Straight 6".....	65
Ruskin Bone Cutting Forceps Straight Jaw 7 1/4".....	65
Ruskin Rongeur 3x10mm Bite Curved 6".....	85
Ruskin Rongeur 4x15mm Bite Curved 7 1/4".....	85
Ruskin Rongeur 4x15mm Bite Straight 7 1/4".....	85
Ruskin-Liston Cutting Forceps, Angled, 7 1/2".....	65
Ruskin-Liston Cutting Forceps, Straight, 7 1/2".....	65
Russian Forceps, 10".....	62
Russian Forceps, 6".....	62
Russian Forceps, 8".....	62
Ryder (French Eye) Needle Holder, Tungsten Carbide, 5".....	49
Ryder (French Eye) Needle Holder, Tungsten Carbide, 6".....	49
Ryder (French Eye) Needle Holder, Tungsten Carbide, 7".....	49
Ryder (French Eye) Needle Holder, Tungsten Carbide, 8".....	49
Ryder (French Eye) Needle Holder, Tungsten Carbide, 9".....	49

## S

Scaler, Jacquette H 6/7.....	18
Schiotz Tonometer.....	54
Schiotz Tonometer, Complete With Case.....	54
Scraper, Angular Point.....	14
Scraper, Curved, with Straight Edge.....	14
Scraper, Curved,With Angle Edge.....	14
Scraper, Double End,Curved,With Angled Edges.....	14
Screwdriver 20mm.....	62
Semken Tissue Forceps, 1X2 Teeth, Curved Tips, Size 5".....	28
Semken Tissue Forceps, 2X3 Teeth, Curved Tips, Size 5".....	28
Senn Retractor 3 Prongs Blunt 6 1/4".....	84
Senn Retractor 3 Prongs Sharp 6 1/4".....	84
Small Pin Hand, Chuck Vise.....	62
Small Stifle Retractor 5" With Speed Lock, Cross Action Tips.....	84
Smillie Knife 6 3/4" Straight.....	67
Snook Hook, Blunt, 8".....	67
Snook Hook, Blunt, 8" Solid Tip.....	67
Spay Pack with Olsen Hegar N.H.....	75
Spay Pack with Olsen Hegar N.H.TC Insert.....	76
Spencer Stitch Scissors 3 1/2".....	100
Spencer Stitch Scissors 3 1/2" Delicate.....	100
Spencer Stitch Scissors, 4 3/4".....	100
Stainless Steel, 18 Guage, Dia .040".....	110
Stainless Steel, 20 Guage, Dia .032".....	110
Stainless Steel, 24 Guage, Dia .020".....	110
Stainless Steel, 25 Guage, Dia .018".....	110
Stainless Steel, 26 Guage, Dia .016".....	110
Stainless Steel, 28 Guage,Dia .012".....	110
Stainless Steel, 30 Guage,Dia .010".....	110
Stainless Steel, 32 Guage,Dia .008".....	110
Stainless Steel, 34 Guage,Dia .006".....	110
Stainless Steel, 36 Guage,Dia .005".....	110
Stainless Steel, 38 Guage,Dia .004".....	110
Stainless Steel, 40 Guage,Dia .003".....	110
Standard Extracting Forceps #1.....	8
Standard Veterinary Eye Pack.....	76
Standard Veterinary Orthopedic Pack.....	77
Sterile Surgical Blade Beaver, Style 61, 12/Box.....	105
Sterile Surgical Blade Beaver, Style 62, 12/Box.....	105
Sterile Surgical Blade Beaver, Style 64, 12/Box.....	105
Sterile Surgical Blade Beaver, Style 67 Slim, 12/Box.....	105
Sterile Surgical Blade Beaver, Style 67, 12/Box.....	105
Sterile Surgical Blades, Box of 100, Carbon Steel Size 10.....	102
Sterile Surgical Blades, Box of 100, Carbon Steel Size 11.....	102
Sterile Surgical Blades, Box of 100, Carbon Steel Size 12.....	102
Sterile Surgical Blades, Box of 100, Carbon Steel Size 12B.....	102
Sterile Surgical Blades, Box of 100, Carbon Steel Size 15.....	102
Sterile Surgical Blades, Box of 100, Carbon Steel Size 15C.....	102
Sterile Surgical Blades, Box of 100, Carbon Steel Size 20.....	103
Sterile Surgical Blades, Box of 100, Carbon Steel Size 21.....	103
Sterile Surgical Blades, Box of 100, Carbon Steel Size 22.....	103

Sterile Surgical Blades, Box of 100, Stainless Steel, Size 23.....	105
Sterile Surgical Blades, Box of 100, Stainless Steel, Size 25.....	101
Sterile Surgical Blades, Box of 100, Stainless Steel, Size 11.....	103
Sterilizer, Needle, Spiral Rack .....	43
Sterilizing Case for schiotz tonometers 6 1/2". 3 1/2". 1 1/4".....	55
Stevens Tenotomy 4 1/2" Curved, Supercut .....	55
Stevens Tenotomy 4 1/2" Straight, Supercut .....	55
Stevens Tenotomy Curved 4 1/2".....	55
Stevens Tenotomy Scissors, Curved 4 1/4" Blunt Tips.....	55
Stevens Tenotomy Scissors, Curved 4 1/4" Blunt Tips, Slender.....	55
Stevens Tenotomy Scissors, Straight 4 1/4" Blunt Tips.....	55
Stevens Tenotomy Scissors, Straight 4 1/4" Blunt Tips, Slender.....	55
Stevens Tenotomy Straight 4 1/2".....	55
Stille Pattern Drill Set.....	68
Stille Pattern Vessel Clamp, 9".....	69
Stille-Luer Ronguer 8 1/2" 9x15mm Bite Curved.....	50
Stille-Luer Ronguer 8 1/2" 9x15mm Bite Straight.....	50
Stille-Luer Ronguer, Curved 8 3/4".....	50
Stille-Luer Ronguer, Curved Angled 9".....	50
Stitch Scissors Blunt Blades 3 3/4" Curved, Fine Tips.....	87
Strabismus Scissors,curved, 4 1/4"/ 11.5 cm.....	56
Strabismus Scissors,Straight, 4 1/4"/ 11.5 cm.....	56
Surgical Needle, 1/2 Circle Cutting Edge.....	107
Surgical Needle, 1/2 Circle Cutting Edge, but taper point.....	107
Surgical Needle, Circle Cutting Edge, Veterinary Heavy Pattern.....	106
Surgical Needle, Circle, Cutting Edge, Regular Eye.....	106
Surgical Needle, Double Curved Heavy Pattern, Cutting Edge.....	109
Surgical Needle, Half Circle Cutting Edge, Veterinary Heavy Pattern.....	107
Surgical Needle, Half Circle, Cutting Edge.....	107
Surgical Needle, Half Curved Heavy pattern, Cutting Edge.....	108
Surgical Needle, Half Curved,Cutting Edge, Regular.....	108
Surgical Needle, Regular Eye .....	108
Surgical Needle, Spring Eye.....	108
Surgical Needle, Spring Eye.....	109
Surgical Needle, With spring eye.....	109
Suture Scissors, Long, 6 1/4".....	100

## T

Tartar Scraper 5 3/4" Triangular Tip.....	14
Tartar Scraper D/E, Curved, Ang, style #12.....	15
Tartar Scraper, Claw Type.....	15
Taylor Percussion Hammer 7".....	33
Taylor Percussion Hammer 8".....	33
Thoms-Allis Tissue Forceps, 6X7 Teeth, 8".....	39
Thumb Dressing Forceps 10" Serrated.....	29
Thumb Dressing Forceps 12" Serrated.....	29
Thumb Dressing Forceps 6" Serrated.....	29
Thumb Dressing Forceps, Serrated Jaws, 4 1/2".....	29
Thumb Dressing Forceps, Serrated Jaws, 5".....	29
Thumb Dressing Forceps, Serrated Jaws, 5 1/2".....	29
Thumb Dressing Forceps, Serrated Jaws, 8".....	29
Thumb Tissue Forceps, 1x2 Teeth, 4 1/2".....	29
Thumb Tissue Forceps, 1x2 Teeth, 10".....	29
Thumb Tissue Forceps, 1x2 Teeth, 12".....	29
Thumb Tissue Forceps, 1x2 Teeth, 5 1/2".....	29
Thumb Tissue Forceps, 1x2 Teeth, 5".....	29
Thumb Tissue Forceps, 1x2 Teeth, 6".....	29
Thumb Tissue Forceps, 1x2 Teeth, 8".....	29
Thumb Tissue Forceps, 2x3 Teeth, 5 1/2".....	30
Thumb Tissue Forceps, 2x3 Teeth, 5".....	30
Thumb Tissue Forceps, 2x3 Teeth, 6".....	30
Thumb Tissue Forceps, 2x3 Teeth, 8".....	30
Thumb Tissue Forceps, 3x4 Teeth, 5 1/2".....	30
Thumb Tissue Forceps, 3x4 Teeth, 5".....	30
Thumb Tissue Forceps, 3x4 Teeth, 6".....	30
Tissue & Cuticle Nipper 4", Convex Jaws, Stainless.....	35
Tissue and Cuticle Nipper, 5", Convex Jaws, Stainless.....	35
Tissue and Cuticle Nipper, Convex Jaws, 4 1/2" Stainless.....	35
Trochlea Rasp 6 3/4".....	71

Troutman-Barraquer Colibri Utility Forceps, 3", 0.4mm.....	56
Troutman-Barraquer Colibri Utility Forceps, 3", 12mm.....	56
U.S. Army Pattern Osteotomes, 6 1/2", 6mm.....	60
U.S. Army Retractor, .625 Wide-Set of 2, 8.5".....	69
Universal Extracting Forceps 17S.....	11
Universal Extracting Forceps, 150S.....	11
Universal Extracting Forceps, 151S.....	11

## V

Vannas After-Cataract Scissors, 3 1/8", Straight.....	15
Vannas Scissors, Angled on Flat, 3".....	15
Verbrugge Bone Holding Forceps, Large.....	65
Verbrugge Bone Holding Forceps, Small.....	65
Vet Advanced Eye Pack.....	74
Vet Advanced Eye Pack with Case.....	77
Vet Starter Eye Pack.....	75
Vet Starter Eye Pack with Case.....	77
"Veterinary Dental Set.....	78
Vienna Felina Vaginal Speculum, Large.....	101
Vienna Felina Vaginal Speculum, Medium.....	101
Vienna Felina Vaginal Speculum, Small.....	101
Volkman Bone Curette Size .0.....	33
Volkman Bone Curette Size 1.....	33
Volkman Bone Curette Size 2.....	33
Volkman Bone Curette Size 2/0.....	33
Volkman Bone Curette Size 3.....	33
Volkman Bone Curette Size 3/0.....	33
Volkman Bone Curette Size 4.....	33
Volkman Bone Curette Size 4/0.....	33
Volkman Bone Curette Size 5.....	33
Volkman Bone Curette Size 5/0.....	33
Volkman Bone Curette Size 6.....	33
Volkman Double Ended Curette, 5" 6 x10mm.....	33
Von Graefe Fixation Forceps, Spring, Non-magnetic, 4 3/8".....	28
Von Graefe Iris Forceps, 2 3/4" Curved, Delicate, 1x2 Teeth.....	56
Von Graefe Iris Forceps, serrated tips, curved, 2 3/4".....	56

## W

Wallace Knee Retractor, 5".....	84
Webster Needle Holder, Smooth Jaws, 5".....	44
Weitlaner Retractor Sharp, 3x4th 6 1/2".....	80
Weitlaner Retractor 3x4th 6 1/2" Blunt.....	80
Weitlaner Retractor 5 1/2" Blunt 3x4 Prongs.....	80
Weitlaner Retractor 5 1/2" Sharp 3x4 Prongs.....	80
Weitlaner Retractor 8" Blunt 3x4 Prongs.....	80
Weitlaner Retractor 8" Sharp 3x4 Prongs.....	80
Weitlaner Retractor 9 1/2" Blunt 3x4 Prongs.....	80
Weitlaner Retractor 9 1/2" Sharp 3x4 Prongs.....	80
White Toe Nail Scissors 4 1/2".....	35
Winged Tip Elevator removeable handle, 2mm, 4 3/4".....	7
Winged Tip Elevator removeable handle, 3mm, 4 3/4".....	7
Winged Tip Elevator removeable handle, 4mm, 4 3/4".....	7
Winged Tip Elevator removeable handle, 5mm, 4 3/4".....	7
Winged Tip Elevator removeable handle, 6mm, 4 3/4".....	7
Winged Tip Elevator removeable handle, 7mm, 4 3/4".....	7
Winged Tip Elevator removeable handle, 8mm, 4 3/4".....	7
Wire Cutting Scissors 4 3/4" Angled, One Serrated Blade.....	100
Wire Cutting Scissors, Straight, 4 1/4".....	101
Wire Twister, Tungsten Carbide Insert Jaws, Size 6".....	59
Wire Twister, Tungsten Carbide Insert Jaws, Size 8".....	59
Wire twister/Shear Cutter.....	66

## X

X-small serrated Bone Holding Forceps.....	66
--	----

## Y

Yankauer Suction Tube 11 3/4" with removable tip.....	32
Yankauer Suction Tube, eplacement tip only.....	32
Young Tongue Forceps, Interchangeable jaw, 6 1/2".....	111

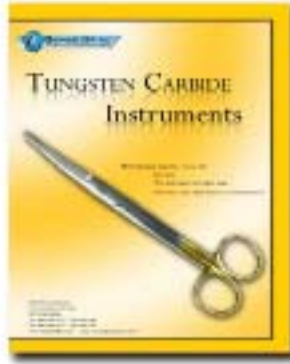

*For Further information contact*

## GermedUSA Inc.

2417 Jericho Tpke #333,  
Garden city park, New York 11040.  
Tel : 516-358-2180 / 800-330-1322  
Fax : 516-358-2182 / 800-260-7177  
email : [sales@germedusa.com](mailto:sales@germedusa.com)  
or  
Visit us at [www.germedusa.com](http://www.germedusa.com)



Download Catalogs at [www.GermedUSA.com](http://www.GermedUSA.com)