

GerVetUSA™

Animal Care at the Highest Quality

If We Don't Have The **Instrument**
You're Looking For We Will **MANUFACTURE** It For You!

VETERINARY DENTAL INSTRUMENTS



GerVetUSA

*The Complete Shop of Surgical
Instruments*



For Details Call: 516-385-3434

Toll Free: 888 814 4650

Fax: 516-358-2182

Toll Free Fax: 888-600-0310

Email: sales@GerVetUSA.com

Website: www.GerVetUSA.com

Address: 1188 Willis Avenue #801 Albertson, NY 11507

GerVetUSA™

Animal Care at the Highest Quality

We are GermedUSA Inc. the manufacturer of fine quality surgical instruments for use in Operating room. Our company specializes in making instruments if you need something special: that's what we do! Our company has 30 years of experience, we are the best! The instruments we make are made for small animal grams in size to an animal that are tons in mass. We use the finest in materials and always meet or exceed FDA requirements, but more important we meet the standards of our customers that use our instruments every day to save someone's special friend.

A lot of our products come from customers we have a line of Neo Grip forceps, needle holders, etc. Neo grip product have very unique design enabling the clinician greater control in the surgery setting, the tool is smaller than most allowing ergonomic control where hand movements are more fluid and less restrictive. The tool has a much smaller profile and suturing is done with ease! We have a line of dental instruments for all your dental needs and add in dental care such as extractions. Our roots are from All Surg Instruments GMBH in Wurmlingen Germany, all our instruments know their heritage!



For Details Call: 516-385-3434
Toll Free: 888 814 4650
Fax: 516-358-2182
Toll Free Fax: 888-600-0310
Email: sales@GerVetUSA.com
Website: www.GerVetUSA.com
Address: 1188 Willis Avenue
#801 Albertson, NY 11507



GerVetUSA
The Complete Shop of Surgical
Instruments

Restraint Instruments



G90-900
Canine Mouth Gag Small Size 4"

G90-905
Canine Mouth Gag Medium Size 5 3/4"

G90-910
Canine Mouth Gag Large Size 6 3/4"



G90-890
Feline Petite Mouth Gag
Light Weight 2 1/4"

G90-895
Feline Mouth Gag Light
Weight 3"



G21-20-02
European Cheek Dilator, Small

G21-20-01
European Cheek Dilator, Large



GD50-2085
Cheek Dilator, Long Reach,
Curved 40mm

GerVetUSA™
Animal Care at the Highest Quality

GerVetUSA
The Complete Shop of Surgical Instruments



V70-265
European Mouth Gag

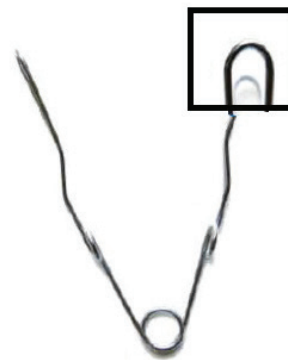

GD50-2086
Rodent Wire Mouth Gag, Lightweight



GD50-1458
Minnesota Cheek Retractor

Dental Scrapers



GD206-101
Scraper, Angular Point



GD206-10
Scraper, Curved, with Straight Edge



GD206-103
Scraper, Curved, With Angle Edge



GD206-104
Scraper, Double End, Curved,
With Angled Edges

Knife Handle

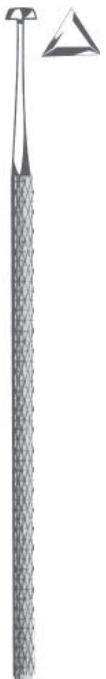

GD206-102
Tartar Scraper 5 3/4"
Triangular Tip



G-206-09
Tartar Scraper D/E,
Curved, Ang, style #12



GD206-11
Tartar Scraper, Claw Type



G08-01
Knife Handle #3



G09-00
Siegel Round Knife Handle #5

GerVetUSA™
Animal Care at the Highest Quality



GD50-1525
Ochsenbein Chisel #1
GD50-1526
Ochsenbein Chisel #2



GD50-1444
Ochsenbein Periodontal
Bone Chisel #3
GD50-1524
Ochsenbein Periodontal
Bone Chisel #4



GD50-1446
Fedi Periodontal Bone Chisel #1
GD50-1447
Fedi Periodontal Bone Chisel #2



GD50-224
Wakefield Bone Chisel 1W
GD50-225
Wakefield Bone Chisel 2W

Chisels

GerVetUSA™
Animal Care at the Highest Quality



GD50-1448
Chandler Bone Chisel #1
GD50-1449
Chandler Bone Chisel #2
GD50-1450
Chandler Bone Chisel #3
GD50-1451
Chandler Bone Chisel #4



GD50-1452
Chandler Bone Chisel #5
GD50-1453
Chandler Bone Chisel #6
GD50-1454
Chandler Bone Chisel #13
GD50-1455
Chandler Bone Chisel #15

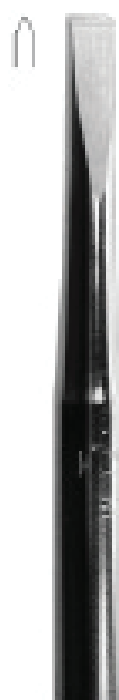

GD50-1456
McFarland Bone Chisel #18



GD50-2052
Wedelstadt Chisel 1/2
GD50-2053
Wedelstadt Chisel 3/4
GD50-2054
Wedelstadt Chisel 5/6

Root Picks/Teasers



GD50-123
Heidbrink Root Tip Pick,
Del H1, Delicate, Straight, 5 1/4"



GD50-126
Heidbrink Root Tip Pick,
Del H2-3, Delicate,
Double Ended, 7 3/4"



GD50-125
Heidbrink Root Tip Pick,
Del H3, Delicate, Left, 5 1/4"



GD50-124
Heidbrink Root Tip Pick,
Del H3, Delicate, Right, 5 1/4"



GD50-1305
Root Tip Pick, Double Ended

Scalers



GD50-1400
Davis Root Tip Teaser 10, Smooth

GD50-1401
Davis Root Tip Teaser 10, Serrated

GD50-1403
Davis Root Tip Teaser 11, Smooth

GD50-1402
Davis Root Tip Teaser 11, Serrated



G206-08
Jacquette Scaler H 6/7



GD50-775
Jacquette Scaler, Double
Ended, 1Y/1Y

GD50-803
Jacquette Sickle Scaler H5/J33

GD50-779
Jacquette Scaler, Double Ended, 2/3

GD50-781
Jacquette Scaler, Double Ended, 2S/3S

GD50-789
Jacquette Scaler, 20/33

GD50-840
Jacquette Scaler, 31/32

GD50-790
Jacquette Scaler, 33/H5

GD50-929
Jacquette Scaler, 34/35

GD50-777
Jacquette Scaler, Double Ended, 2Y/3Y

GD50-774
Jacquette Scaler, Single Ended, U-15



GD50-830
Towner-Jacquette
Scaler U15-30



GD50-308
OffSet Heavy Scaler, Remington 3/4
GD50-309
OffSet Heavy Scaler, S-129



GD50-314
Tartar Hoe, Heavy
Kirkland 13K/13KL



GD50-902
Interproximal Scaler 204S,
Double Ended



GD50-02
Sickle/ Hoe Scaler H5/H48



GD50-03
Sickle/Hoe Scaler
Small YG-15/XS-15



GD50-01
OffSet Sickle Scaler H6/H7

Scalers

GerVetUSA™
Animal Care at the Highest Quality



GD50-04
Sickle Scaler N-135



GD50-05
Sickle Scaler Small,
Curved Z-135



GD50-06
Sickle Scaler Small,
Younger-Good 7/8



GD50-08
Morse Scaler 0-00



GD50-07
Scaler Delicate
YG-15/Morse 00



GD50-947
Slim Dental Curette



GD50-757
Columbia Curette 4L-4R TTDE, Double Ended,
Cut back, Feline Universal Curette

GD50-758
Columbia Curette 13-14 Fine, Double Ended



GD50-777-1
Curette Style H6/7



GD50-327
Miller Periosteal Curette #10

Curettes



0



1/2



7/8



11/12



13/14

GD50-84
Feline Gracey 13/14
Curette, Double Ended



GD50-307

GD50-306
Universal Curette 2R/2L
GD50-307
Universal Curette 4R/4L



GD50-549

GD50-89
Barnhart Curette 5/6
GD50-555
Barnhart Curette 5/6, Cut Back, Feline
Universal Curette

GD50-80
Feline Curette, Double Ended
GD50-81
Feline Gracey 1/2 Curette,
Double Ended

GD50-82
Feline Gracey 7/8 Curette, Double Ended
GD50-83
Feline Gracey 11/12 Curette, Double Ended

Curettes



- GD50-157**
Gracey Curettes 1/2
- GD50-751**
Gracey Curettes 3/4
- GD50-753**
Gracey Curette 5/6
- GD50-160**
Gracey Curettes 7/8
- GD50-754**
Gracey Curettes 9/10
- GD50-755**
Gracey Curettes 11/12
- GD50-756**
Gracey Curettes 13/14
- GD50-813**
Gracey Curettes 11/14
- GD50-820**
Gracey Curettes 12/13
- GD50-811**
Gracey Curettes 15/16
- GD50-812**
Gracey Curettes 17/18

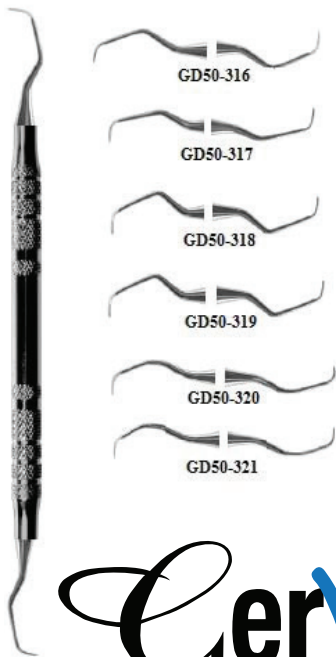
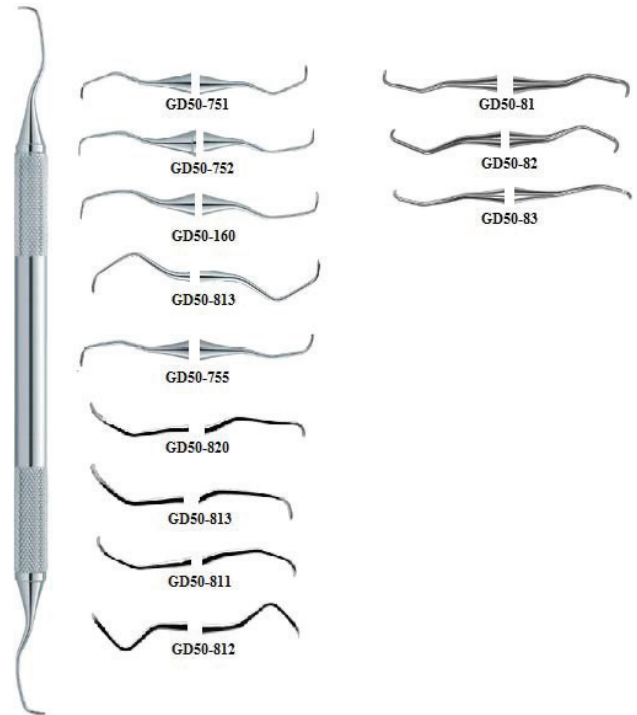

- GD50-315**
Gracey Deep Pocket Curette 1/2 Long
- GD50-316**
Gracey Deep Pocket Curette 3/4 Long
- GD50-317**
Gracey Deep Pocket Curette 5/6 Long
- GD50-318**
Gracey Deep Pocket Curette 7/8 Long
- GD50-319**
Gracey Deep Pocket Curette 9/10 Long
- GD50-320**
Gracey Deep Pocket Curette 11/12 Long
- GD50-321**
Gracey Deep Pocket Curette 13/14 Long



- GD50-311**
McCalls Curette, Style 11/14
- GD50-900**
McCalls Curette, Style 13S/14S
- GD50-761**
McCalls Curette, Style 13/14
- GD50-312**
McCalls Curette, Style 13/14, Feline
- GD50-310**
McCalls Curette, Style 17/18

GD50-987
Subgingival Curette

GerVetUSA™
Animal Care at the Highest Quality

For Details Call: 516-385-3434

Toll Free: 888 814 4650

Fax: 516-358-2182

Toll Free Fax: 888-600-0310

Email: sales@GerVetUSA.com

Website: www.GerVetUSA.com

**Address: 1188 Willis Avenue
#801 Albertson, NY 11507**

GerVetUSA

The Complete Shop of Surgical Instruments

Bone Currettes



GD50-204
Bone Currettes, Molt, No. 1
GD50-205
Bone Currettes, Molt, No. 2



GD50-209
Bone Currettes, Molt, No. 2/4,
Double Ended



GD50-1432
Miller Bone Curette #10

GD50-1433
Miller Bone Curette #10,
Finer, Feline use

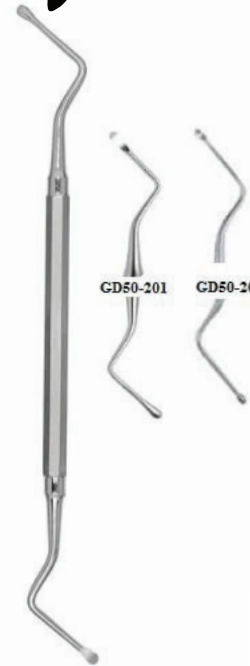

GD50-203
Lucas Bone Curette, No.87

GD50-201
Lucas Bone Curette, No. 85

GD50-202
Lucas Bone Curette, No. 86



GD50-666
Bone Curette,
Double Ended,
3mm/3mm, Straight

Explorers & Probes



GD50-2016
DeForge Canine Periosteal
Probe, Markings 3,6,9,12,15 &
18mm, Style One

GD50-2017
DeForge Canine Periosteal
Probe, Markings 3,6,9,12,15
& 18mm, Style Two



GD50-2018
DeForge Feline Periosteal
Probe, Markings 1,2,3,5,7,8,9
& 10mm Style One

GD50-2019
DeForge Feline Periosteal
Probe, Markings 1,2,3,5,7,8,9
& 10mm Style Two

GD50-2019



GD50-2091
Resorptive Lesion Probe



GD50-301
Dental Explorer 2D

Explorers & Probes



GD50-303
Dental Explorer, 17

GD50-303-1
Dental Explorer and Graduated
Probe, D/E style PE1-23



GD50-300
Dental Explorer, Style 7



GD50-304
Dental Explorer, style 3A



GD50-85
Williams Probe/Explorer, Markings
are 1,2,3,5,7,8,9 & 10mm

GD50-86

GD50-86
Williams Probe/Explorer, Markings
are 1,2,3,4,5,6,7,8,9,1
0,11,12,13,14 & 15mm



GD50-1537
Graduated Probe, Style "C"



GD50-87
Explorer TU17/23, Double Ended



GD50-735
Probe 20-23 Explorer TT DE



GD50-88
Explorer Endo DG-16, Double Ended



GD50-99
Probe/Explorer, Markings are
1,2,3,5,7,8,9 & 10mm

GD50-740

GD50-740
Probe/Explorer, Double Ended,
3, 6, 9, 12, 15 & 18mm Markings

GD50-750

GD50-750
Probe/Explorer, Double Ended,
3, 6, 9 & 12mm Markings

Excavators & Burnishers



GD50-739
Dental Excavator #17
GD50-741
Dental Excavator #18
GD50-742
Dental Excavator #19
GD50-2067
Dental Excavator #31L
GD50-1523
Excavator Style #33L



GD50-2069
Dental Burnisher #2DE
GD50-829
Dental Burnisher #27/29
GD50-831
Dental Burnisher #21B



GerVetUSA

The Complete Shop of Surgical Instruments



GD50-1520
Excavator Style #38/39



GD50-1521
Excavator Style #61/62



GerVetUSA™
Animal Care at the Highest Quality

For Details Call: 516-385-3434

Toll Free: 888 814 4650

Fax: 516-358-2182

Toll Free Fax: 888-600-0310

Email: sales@GerVetUSA.com

Website: www.GerVetUSA.com

**Address: 1188 Willis Avenue
#801 Albertson, NY 11507**

Bone Files



GD50-210
Bone File #10, Double Ended
GD50-702
Bone File #33, Double Ended



GD50-703
Miller Bone File #45, Double Ended
GD50-704
Miller Bone File #64, Double Ended



GD50-214
Howard Bone File #12, Double Ended
GD50-215
Howard Bone File #12A, Double Ended
GD50-216
Howard Bone File #12CA, Double Ended



GD50-217
Polokoff Bone File #1, Double Ended



GD50-400
Hirschfeld File, 3-7
GD50-399
Hirschfeld File, 5-11
GD50-401
Hirschfeld File, 9-10



GD50-322
Schluger 9/10 Furcation File
GD50-323
Sugarman 1S/2S Furcation File
GD50-324
Sugarman 3S/4S Furcation File

Elevators



GD50-920
Luxating Elevator, Curved
3mm, Fiber Handle

GD50-925
Luxating Elevator, Curved
5mm, Fiber Handle

GD50-910
Luxating Elevator, Straight
3mm, Fiber Handle

GD50-927
Luxating Elevator, Straight
5mm, Fiber Handle



GD50-77
Holmstrom Modified Elevator 5H

GD50-78
Holmstrom Eisner Modified
Elevator 5EH

GD50-79
Holmstrom Modified Elevator 15H

GD50-804
Holmstrom Modified Elevator 16H

GD50-810
Holmstrom Eisner Elevator 5E



GD50-808
Dental Elevator #5

GD50-806
Modified Elevator 100G

GD50-807
Dental Elevator 100G



GD40-30
Luxating Elevator 2mm Blade Left

GD40-31
Luxating Elevator 2mm Blade Right



GD40-09
Luxating Elevator, Curved Tip
2mm, 5 3/4"

GD40-10
Luxating Elevator, Curved
Tip 3mm, 5 3/4"

GD40-11
Luxating Elevator, Curved Tip
4mm, 5 3/4"

GD40-12
Luxating Elevator, Curved Tip
5mm, 5 3/4"

GD40-22
Luxating Elevator, Curved Tip
2mm, 5 3/4"



GD40-19
Luxating Elevator, Inside
Curved Tip 2mm, 5 3/4"

GD40-17
Luxating Elevator, Inside
Curved Tip 3mm, 5 3/4"

GD40-24
Luxating Elevator, Inside-
Curved Tip 3mm, 5 3/4"

GD40-26
Luxating Elevator, Inside
Curved Tip 4.5mm, 5 3/4"

GD40-27
Luxating Elevator, Inside
Curved Tip 5mm, 5 3/4"



Elevators



- GD40-21**
Luxating Elevator, Back Curved Tip 2mm, 5 3/4"
- GD40-23**
Luxating Elevator, Back Curved Tip 3mm, 5 3/4"
- GD40-25**
Luxating Elevator, Back Curved Tip 4mm, 5 3/4"
- GD40-18**
Luxating Elevator, Back Curved Tip 4.5mm, 5 3/4"
- GD40-28**
Luxating Elevator, Back Curved Tip 5mm, 5 3/4"



- GD40-13**
Luxating Elevator, Straight Tip 2mm, 5 3/4"
- GD40-14**
Luxating Elevator, Straight Tip 3mm, 5 3/4"
- GD40-15**
Luxating Elevator, Straight Tip 4mm, 5 3/4"
- GD40-20**
Luxating Elevator, Straight Tip 4.5mm, 5 3/4"
- GD40-16**
Luxating Elevator, Straight Tip 5mm, 5 3/4"

GerVetUSA

The Complete Shop of Surgical Instruments



- GD50-352**
Feline Elevator, Extra Short 3S
- GD50-355**
Feline Elevator, Extra Short 3
- GD50-356**
Feline Elevator, Extra Short 4
- GD50-357**
Feline Elevator, Extra Short 5
- GD50-358**
Feline Elevator, Extra Short 5H
- GD50-359**
Feline Elevator, Extra Short 15
- GD50-360**
Feline Elevator, Extra Short 16
- GD50-354**
Feline Elevator, Extra Short 30G
- GD50-353**
Feline Elevator, Extra Short 31G
- GD50-340**
Feline Surgical Elevator #46
- GD50-338**
Feline Elevator, Extra Short 100G



GD50-341
Howard Surgical Elevator 1



- GD50-1200**
Cryer Elevator #21
- GD50-1210**
Cryer Elevator #22
- GD50-116**
Cryer Surgical Elevator #44
- GD50-117**
Cryer Surgical Elevator #45

Elevators



- GD50-497**
Surgical Feline Elevator #5
- GD50-344**
Surgical Feline Elevator #15
- GD50-345**
Surgical Feline Elevator #16
- GD50-338**
Surgical Feline Elevator 100G



GD50-130
West Surgical Feline
Periosteal Elevator DEL W2

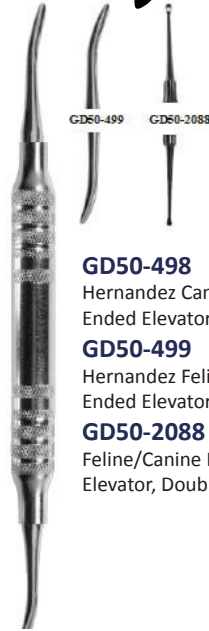

- GD50-498**
Hernandez Canine Double
Ended Elevator
- GD50-499**
Hernandez Feline Double
Ended Elevator
- GD50-2088**
Feline/Canine Periosteal
Elevator, Double Ended 2/2



GD50-396
Cameron Dental Elevator

GerVetUSA

The Complete Shop of Surgical Instruments



- GD50-387**
Dental Elevator #301
- GD50-388**
Dental Elevator #302
- GD50-389**
Dental Elevator #303
- GD50-390**
Dental Elevator #304
- GD50-391**
Dental Elevator #305
- GD50-392**
Dental Elevator #306
- GD50-393**
Dental Elevator #307
- GD50-394**
Dental Elevator #308
- GD50-395**
Dental Elevator #309



- GD50-397**
Dental Elevator #34 Heavy
- GD50-398**
Dental Elevator #77
- GD50-1100**
Dental Elevator #77R



- GD50-1300**
Woodward Elevator #6
- GD50-1301**
Woodward Elevator #7

Elevators



GD50-1303
Root Tip Elevator #94
GD50-1304
Root Tip Elevator #95



GD50-1306
Root Elevator 1.3mm
Straight Tip
GD50-1307
Root Elevator 1.3mm
Inside Curved Tip



GD50-1308
Root Elevator 1.3mm
Outside Curved Tip

GD50-1302
Warwick James Root Elevator,
Straight

GerVetUSA
The Complete Shop of Surgical Instruments



GD50-1404
Richter #3 Root Elevator,
Double Ended



GD50-1405
GerMed Root Tip Elevator
31G/30G Large Handle
GD50-2105
GerMed Root Tip Elevator
31G/30G Short Handle



GD50-1408
Root Elevator 1.3mm 3S,
Long Handle
GD50-1409
Root Elevator 1.3mm 31G,
Long Handle



GD50-1410
Root Elevator 1.3mm 30G,
Long Handle

Elevators



GD50-12
Freer Periosteal Elevator,
Double Ended

GD50-798
Freer Periosteal Elevator,
Double Ended, M9 Long



GD50-133
Molt 9 Periosteal Elevator,
Double Ended M9



GD50-132
Seldin DEL S23 Periosteal Elevator



GD50-133S
Molt 9 Periosteal Elevator,
Double Ended M9, Short Handle

GerVetUSA

The Complete Shop of Surgical Instruments



GD50-1412
GerMed Periosteal Elevator 8

GD50-1413
GerMed Periosteal Elevator 9

GD50-1414
GerMed Periosteal Elevator 9M

GD50-1415
GerMed Periosteal Elevator 10

GD50-1416
GerMed Periosteal Elevator 11

GD50-1417
GerMed Periosteal Elevator 13

GD50-1418
GerMed Periosteal Elevator 14S

GD50-1419
GerMed Periosteal Elevator 19

GD50-1420
GerMed Periosteal Elevator 50

GD50-1421
GerMed Periosteal Elevator 51



GD50-1422
Freer Nasal Periosteal Elevator

GD50-1423
Freer Periosteal Elevator 15G

GD50-1424
Freer Periosteal Elevator 16G,
One bent end

GD50-1425
Freer Periosteal Elevator 15G, Mini

GD50-1426
Freer Periosteal Elevator 16G,
One bent end, Mini

Elevators



GD50-1427
Hufz Prichard Periosteal Elevator



GD50-1428
Shanallec Periosteal Elevator, Mini Prichard



GD50-618
Deciduous Elevator Curette
Style, 5mm/5mm Ends, Straight

GD50-613
Deciduous Elevator Curette
Style, 4mm/4mm Ends, Curved,
Forward Angle

GD50-617
Deciduous Elevator Curette
Style, 3mm/3mm Ends, Straight

GD50-633
Deciduous Elevator Curette
Style, 3mm/3mm Ends, Curved

GD50-620
Deciduous Elevator Curette
Style, 2mm/2mm Ends, Curved



GD50-1431
Molt 5 Periosteal Elevator,
Single Ended



GD50-2070
Dental Cleoid Discoid #1/2, Small

GD50-749
Dental Cleoid Discoid #89/92, Medium

GD50-748
Dental Cleoid Discoid #3/6, Large



GD50-2093
Deciduous Elevator,
Curved 2mm, Small

GD50-2094
Deciduous Elevator,
Curved 3mm, Medium

GD50-2095
Deciduous Elevator,
Curved 4mm, Large



GD50-1429
GerMed Periosteal Elevator
Single Ended 6

GD50-1430
GerMed Periosteal Elevator
Single Ended 7

Winged Elevators



- GD50-190**
Winged Elevator 2mm, Short Handle
- GD50-191**
Winged Elevator 3mm, Short Handle
- GD50-192**
Winged Elevator 4mm, Short Handle
- GD50-193**
Winged Elevator 5mm, Short Handle
- GD50-194**
Winged Elevator 6mm, Short Handle
- GD50-195**
Winged Elevator 7mm, Short Handle
- GD50-196**
Winged Elevator 8mm, Short Handle



- GD50-197**
Winged Elevators 2mm, Long Handle
- GD50-198**
Winged Elevators 3mm, Long Handle
- GD50-199**
Winged Elevators 4mm, Long Handle
- GD50-180**
Winged Elevators 5mm, Long Handle
- GD50-181**
Winged Elevators 6mm, Long Handle
- GD50-182**
Winged Elevators 7mm, Long Handle
- GD50-183**
Winged Elevators 8mm, Long Handle



GD50-508
Removable Handle for Winged Elevator-Handle Only



- GD50-501**
Winged Tip Elevator with removable handle, 2mm, 4 3/4"
- GD50-502**
Winged Tip Elevator with removable handle, 3mm, 4 3/4"
- GD50-503**
Winged Tip Elevator with removable handle, 4mm, 4 3/4"
- GD50-504**
Winged Tip Elevator with removable handle, 5mm, 4 3/4"
- GD50-505**
Winged Tip Elevator with removable handle, 6mm, 4 3/4"
- GD50-506**
Winged Tip Elevator with removable handle, 7mm, 4 3/4"
- GD50-507**
Winged Tip Elevator with removable handle, 8mm, 4 3/4"
- GD50-509**
Mini Tightening Ratchet

For Details Call: 516-385-3434
Toll Free: 888 814 4650
Fax: 516-358-2182
Toll Free Fax: 888-600-0310
Email: sales@GerVetUSA.com
Website: www.GerVetUSA.com
Address: 1188 Willis Avenue
#801 Albertson, NY 11507



Winged Elevators



- GD50-362**
Winged Elevator Back-Bent 1mm
- GD50-363**
Winged Elevator Back-Bent 2mm
- GD50-364**
Winged Elevator Back-Bent 3mm
- GD50-365**
Winged Elevator Back-Bent 4mm
- GD50-369**
Winged Elevator Back-Bent 6mm
- GD50-367**
Winged Elevator Back-Bent 8mm



- GD50-370**
Winged Elevator Inside-Bent 1mm
- GD50-371**
Winged Elevator Inside-Bent 2mm
- GD50-372**
Winged Elevator Inside-Bent 3mm
- GD50-373**
Winged Elevator Inside-Bent 4mm
- GD50-374**
Winged Elevator Inside-Bent 6mm
- GD50-375**
Winged Elevator Inside-Bent 8mm

GerVetUSA

The Complete Shop of Surgical Instruments



- GD50-382**
Winged Elevator Curette Style, Ends are 1mm/2mm
- GD50-962**
Winged Elevator, Double Ended, Ends are 1mm/2mm Inside Bent
- GD50-961**
Winged Elevator, Double Ended, Ends are 1mm/2mm, Back Bent
- GD50-383**
Winged Elevator Curette Style, Ends are 3mm/4mm
- GD50-408**
Winged Elevator, Double Ended, Ends are 3mm/4mm, Back Bent
- GD50-960**
Winged Elevator, Double Ended, Ends are 3mm/4mm, Inside Bent
- GD50-963**
Winged Elevator, Double Ended, Ends are 7mm/8mm, Inside Bent
- GD50-964**
Winged Elevator, Double Ended, Ends are 7mm/8mm, Back Bent
- GD50-608**
Winged Elevator Curette Style, Ends are 7mm/8mm

- GD50-948**
Winged Elevator, Double Ended, Ends are 3mm/3mm Straight
- GD50-600**
Winged Elevator Curette Style, Ends are 8mm/6mm, Inside Bent
- GD50-601**
Winged Elevator Curette Style, Ends are 7mm/5mm, Straight
- GD50-602**
Winged Elevator Curette Style, Ends are 7mm/5mm, Backward Angle
- GD50-603**
Winged Elevator Curette Style, Ends are 4mm/4mm, Outside bent, Backward Angle
- GD50-604**
Winged Elevator Curette Style, Ends are 4mm/4mm, Straight
- GD50-605**
Winged Elevator Curette Style, Ends are 8mm/6mm, Straight
- GD50-606**
Winged Elevator Curette Style, Ends are 9mm/6mm, Forward Angle

- GD50-607**
Winged Elevator Curette Style, Ends are 4mm/4mm, Forward Angle
- GD50-609**
Winged Elevator Curette Style, Ends are 3mm/2mm, Forward Angle
- GD50-611**
Winged Elevator Curette Style, Ends are 3mm/2mm, Straight
- GD50-384**
Winged Elevator Curette Style, Ends are 6mm/8mm, Outside Bent
- GD50-949**
Winged Elevator, Double Ended, Ends are 3mm/3mm Back Bent
- GD50-610**
Winged Elevator, Double Ended, Ends are 3mm/4mm Out- side Bent

Winged Elevators



GD50-510

Winged Elevator Short Handle
1.2mm Backward Angle

GD50-511

Winged Elevator Short Handle
1.2mm Forward Angle

GD50-542

Winged Elevator Short
Handle 1.2mm Straight

GD50-512

Winged Elevator Short Handle
2mm Backward Angle

GD50-513

Winged Elevator Short Handle
2mm Forward Angle

GD50-544

Winged Elevator Short Handle
2mm Straight

GD50-514

Winged Elevator Short Handle
3mm Backward Angle

GD50-515

Winged Elevator Short Handle
3mm Forward Angle

GD50-545

Winged Elevator Short Handle
3mm Straight

GD50-516

Winged Elevator Short Handle
4mm Backward Angle

GD50-517

Winged Elevator Short Handle
4mm Forward Angle

GD50-546

Winged Elevator Short Handle
4mm Straight

GD50-518

Winged Elevator Short Handle
5mm Backward Angle

GD50-519

Winged Elevator Short Handle
5mm Forward Angle

GD50-547

Winged Elevator Short Handle
5mm Straight

GD50-520

Winged Elevator Short Handle
6mm Backward Angle

GD50-521

Winged Elevator Short Handle
6mm Forward Angle

GD50-548

Winged Elevator Short Handle
6mm Straight

GD50-522

Winged Elevator Short Handle
7mm Backward Angle

GD50-523

Winged Elevator Short Handle
7mm Forward Angle

GD50-549

Winged Elevator Short Handle
7mm Straight

GD50-524

Winged Elevator Short Handle
8mm Backward Angle

GD50-525

Winged Elevator Short Handle
8mm Forward Angle

GD50-550

Winged Elevator Short Handle
8mm Straight

Root Elevators



GD50-526

Winged Elevator Long Handle
1.2mm Backward Angle

GD50-527

Winged Elevator Long Handle
1.2mm Forward Angle

GD50-528

Winged Elevator Long Handle
2mm Backward Angle

GD50-529

Winged Elevator Long Handle
2mm Forward Angle

GD50-530

Winged Elevator Long Handle
3mm Backward Angle

GD50-531

Winged Elevator Long Handle
3mm Forward Angle

GD50-532

Winged Elevator Long Handle
4mm Backward Angle

GD50-533

Winged Elevator Long Handle
4mm Forward Angle

GD50-534

Winged Elevator Long Handle
5mm Backward Angle

GD50-535

Winged Elevator Long Handle
5mm Forward Angle

GD50-536

Winged Elevator Long Handle
6mm Backward Angle

GD50-537

Winged Elevator Long Handle
6mm Forward

GD50-538

Winged Elevator Long Handle
7mm Backward Angle

GD50-539

Winged Elevator Long Handle
7mm Forward Angle

GD50-540

Winged Elevator Long Handle
8mm Backward

GD50-541

Winged Elevator Long Handle
8mm Forward Angle



Root Elevators



GD50-115
Root Elevator, Crane Pick, DEL46



GD50-330
Seldin Surgical Elevator 345



GD50-331
Apexo Surgical Elevator #301



GD50-100
Root Elevators, Apical, DEL 301



GD50-114
Root Elevator, Crane Pick, DEL 345



GD50-101
Root Elevators, Apical, DEL 302HF



GD50-104
Root Elevators, Apical, DEL 303HF



GD50-342
Surgical Root Elevator #100



GD50-343
Surgical Root Elevator #100R

Root Elevators



GD50-102
Apical Del 303 Elevator, 5 3/4"



GD50-113
Root Elevator, Crane Pick, DEL 34



GD50-120
Root Elevators, DEL 78



GD50-627
Root Tip Elevator, Del 79,
Curved Right, 5 1/2"



GD50-629
Root Tip Elevator, Del 80,
Curved Left, 5 1/2"



GD50-2015
Corn Luxation Instrument



GD50-951
Crossley Luxation Exdontia Instrument #1

GD50-952
Crossley Luxation Exdontia Instrument #2

G21-20-05
Crossley Luxation Exdontia Instrument #3

G21-20-06
Crossley Luxation Exdontia Instrument #4

Luxation Instruments



For Details Call: 516-385-3434

Toll Free: 888 814 4650

Fax: 516-358-2182

Toll Free Fax: 888-600-0310

Email: sales@GerVetUSA.com

Website: www.GerVetUSA.com

Address: 1188 Willis Avenue

#801 Albertson, NY 11507

Filling Instruments



GD50-2075
Plastic Filling Dental Instrument 1H
GD50-2076
Plastic Filling Dental Instrument 8A
GD50-2077
Plastic Filling Dental Instrument 11
GD50-2078
Plastic Filling Dental Instrument A6
GD50-2079
Plastic Filling Dental Instrument CJZ



GD50-819
Woodson Plastic Filling Dental Instrument W3

Periotomes



For Details Call: 516-385-3434
Toll Free: 888-814-4650
Fax: 516-358-2182
Toll Free Fax: 888-600-0310
Email: sales@GerVetUSA.com
Website: www.GerVetUSA.com
Address: 1188 Willis Avenue
#801 Albertson, NY 11507



GD50-1434
Kurtzman Periotome Flat Blade
Socket Expander
GD50-1435
Kurtzman Periotome Contra
Angled, for Posteriors



GD50-1436
GerMed Periotome #1
GD50-1437
GerMed Periotome #2
GD50-1438
GerMed Periotome #3
GD50-1439
GerMed Periotome #4



GD50-1440
GerMed Periotome #5, Small Gouge

Plugger/Spreader

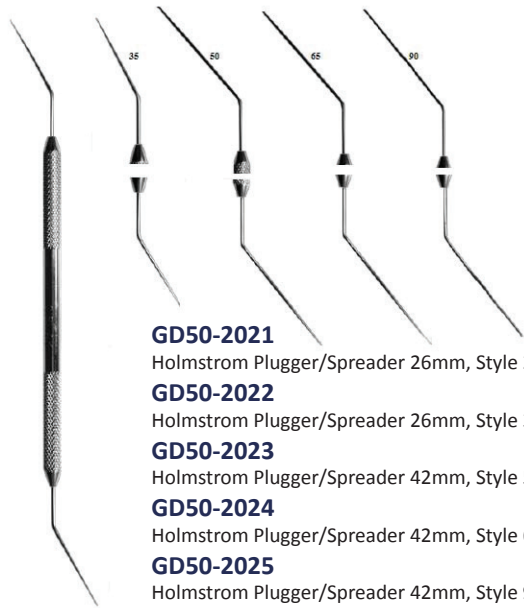

- GD50-2021**
Holmstrom Plugger/Spreader 26mm, Style 20
- GD50-2022**
Holmstrom Plugger/Spreader 26mm, Style 35
- GD50-2023**
Holmstrom Plugger/Spreader 42mm, Style 50
- GD50-2024**
Holmstrom Plugger/Spreader 42mm, Style 65
- GD50-2025**
Holmstrom Plugger/Spreader 42mm, Style 90



- GD50-2026**
Holmstrom Plugger, Single Ended, Straight, Style 20
- GD50-2027**
Holmstrom Spreader, Single Ended, Straight, Style 20
- GD50-2028**
Holmstrom Plugger, Single Ended, Straight, Style 35
- GD50-2029**
Holmstrom Spreader, Single Ended, Straight, Style 35
- GD50-2030**
Holmstrom Plugger, Single Ended, Straight, Style 50
- GD50-2031**
Holmstrom Spreader, Single Ended, Straight, Style 50
- GD50-2032**
Holmstrom Plugger, Single Ended, Straight, Style 65
- GD50-2033**
Holmstrom Spreader, Single Ended, Straight, Style 65
- GD50-2034**
Holmstrom Plugger, Single Ended, Straight, Style 90
- GD50-2035**
Holmstrom Spreader, Single Ended, Straight, Style 90

Plugger/Spreader



- GD50-2036**
Holmstrom Finger Plugger, Removable Handle, Straight, Style 90
- GD50-2037**
Holmstrom Finger Plugger, Removable Handle, Angled, Style 50
- GD50-2038**
Holmstrom Finger Plugger, Removable Handle, Straight, Style 90
- GD50-2039**
Holmstrom Finger Plugger, Removable Handle, Angled, Style 50



- GD50-2040**
Finger Plugger Handle Only, Single End
- GD50-2041**
Finger Plugger Handle Only, Double Ended



- GD0-2073**
Res Plugger H-1

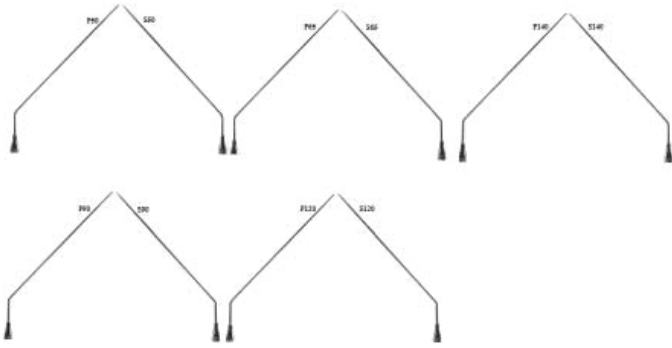

GD50-2042

Plugger, Extra Long, Straight,
Size 50, 120mm Long Point

GD50-2043

Spreader Extra Long, Straight,
Size 50, 120mm Long Point

GD50-2044

Plugger, Extra Long, Straight,
Size 65, 120mm Long Point

GD50-2045

Spreader, Extra Long, Straight,
Size 65, 120mm Long Point

GD50-2046

Plugger, Extra Long, Straight,
Size 90, 120mm Long Point

GD50-2047

Spreader, Extra Long, Straight,
Size 90, 120mm Long Point

GD50-2048

Plugger, Extra Long, Straight,
Size 120, 120mm Long Point

GD50-2049

Spreader, Extra Long, Straight,
Size 120, 120mm Long Point

GD50-2050

Plugger, Extra Long, Straight,
Size 140, 120mm Long Point

GD50-2051

Spreader, Extra Long, Straight,
Size 140, 120mm Long Point



GD50-824

Black Amalgam Plugger 1/2

GD50-2074

Black Amalgam Plugger 2/3

GD50-825

Marquette Amalgam Plugger 0/1

Knives



GD50-796

Orban Knife 1-2



GD50-325

Kirkland 15K/16K Gingivectomy Knife



GD50-326

Orban 1/2 Gingivectomy Knife

Spatula & Carvers



GD50-2055
Spatula #24

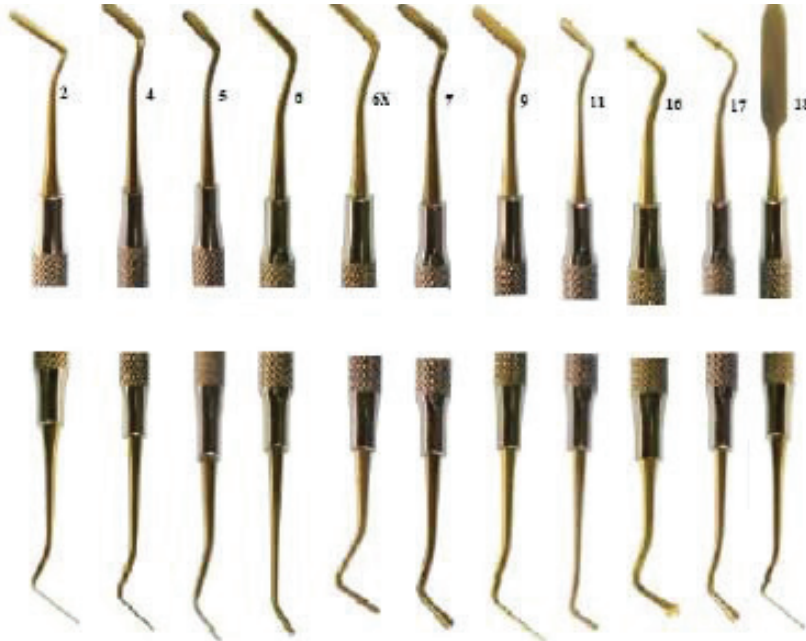

- GD50-2056**
Composite Instrument Style 2
- GD50-2057**
Composite Instrument Style 4
- GD50-2058**
Composite Instrument Style 5
- GD50-2059**
Composite Instrument Style 6
- GD50-2060**
Composite Instrument Style 6X
- GD50-2061**
Composite Instrument Style 7
- GD50-2062**
Composite Instrument Style 9
- GD50-2063**
Composite Instrument Style 11
- GD50-2064**
Composite Instrument Style 16
- GD50-2065**
Composite Instrument Style 17
- GD50-2066**
Composite Instrument Style 18

GerVetUSA

The Complete Shop of Surgical Instruments

Dental Mirrors



GD50-2071
Hollenback Dental
Wax Carver #1/2
GD50-993
Hollenback Dental
Wax Carver #35



GD50-2072
Minnesota Dental
Wax Carver 1



GD50-2083
Rabbit and Rodent Spat



- GD50-614**
Deluxe Mirror Handle Cone Socket
- GD50-592**
Mirror Handle Cone Socket/Mirror #3
- GD50-593**
Mirror Handle Cone Socket/Mirror #4
- GD50-612**
Octagonal Mirror Handle, Cone socket

Scissors



GD50-153
Locklin Gum Scissors, Straight
Shanks, One Serrated Blade, 6 1/4"
GD50-154
Locklin Gum Scissors, Curved
Shanks, One Serrated Blade, 6 1/4"



G18-280
Vannas After-Cataract Scissors,
3 1/8", Straight
G18-282
Vannas Scissors, Angled on Flat, 3"



GD50-404
Kelly Dental Gum Scissors 6 1/4", Curved
GD50-402
Kelly Dental Gum Scissors 1/4", Straight



GD50-1495
Goldman Fox Scissors 5" Straight
GD50-1496
Goldman Fox Scissors 5" Curved



GD50-262
Iris Dental Gum Scissors 4 1/2", Curved
GD50-261
Iris Dental Gum Scissors 4 1/2", Straight



GD50-267
Iris Dental Gum Scissors 4 1/2", Angled



GD50-266
Iris Dental Gum Side
Cutting Scissors 4 1/2"

Scissors



GD50-915
LaGrange Scissors 4 1/2"
Double Curved



GD50-250
Metzenbaum Gum Scissors
5 1/2" Angled



G10-133
Metzenbaum Gum Scissors
5 3/2" Straight

G10-36
Metzenbaum Gum Scissors
5 1/2" Curved



GD50-1499
Kilner Tenotomy Scissor 4 1/4" Straight

GD50-2000
Kilner Tenotomy Scissor 4 1/4" Curved



G10-35
Joseph Scissors 5 1/2" Straight

GD50-923
Joseph Scissors 5 1/2" Curved



GD50-1213
Castroviejo Micro Periodontal
Scissors 3 1/2" Curved

GD50-2001
Castroviejo Micro Periodontal
Scissors 5 1/2" Curved



GD50-2002
Offset Micro Surgical Scissor
6" Straight



GD50-1494
Precision Scissor 4 1/2"
Slightly Curved

Scissors



GD50-2003
Noyes Micro Angled Scissors 4"

GD50-2004
Noyes Micro Scissors 4" Curved

GD50-2005
Noyes Micro Scissors 4" Straight



GD50-2084
Rabbit Molar Cutters



GD50-1490
Kelly Dental Gum Scissors 6 1/4",
Curved, Tungsten Carbide

GD50-1491
Kelly Dental Gum Scissors 6
1/4", Straight, Tungsten Carbide

Scissors-Tungsten Carbide



GD50-265
Iris Dental Gum Scissors 4 1/2",
Curved, Tungsten Carbide

GD50-263
Iris Dental Gum Scissors 4 1/2",
Straight, Tungsten Carbide



GD50-1493
LaGrange Scissors 4 1/2" Double
Curved, Tungsten Carbide



G17-1200
Goldman Fox Scissors 5"
Straight, Tungsten Carbide

GD50-1498
Goldman Fox Scissors 5"
Curved, Tungsten Carbide

GerVetUSA™
Animal Care at the Highest Quality

Scissors-SuperCut



G10-SC-44
Iris Dental Gum Scissors 4 1/2",
Straight, SuperCut

G10-SC-45
Iris Dental Gum Scissors 4 1/2",
Curved, SuperCut



GD50-1492
LaGrange Scissors 4 1/2" Double
Curved, SuperCut



GD50-SC-766
Goldman Fox Scissors 5" Curved,
SuperCut



G18-56
Castroviejo Needle Holder,
5 1/4", Straight Jaw With Catch



GD50-2010
Castroviejo Micro Surgical Needle
Holder 5 1/2" Serrated, Straight
With Catch, Round Body Style



GD50-2013
Castroviejo Offset Micro Surgical
Needle Holder 5 1/2" Serrated

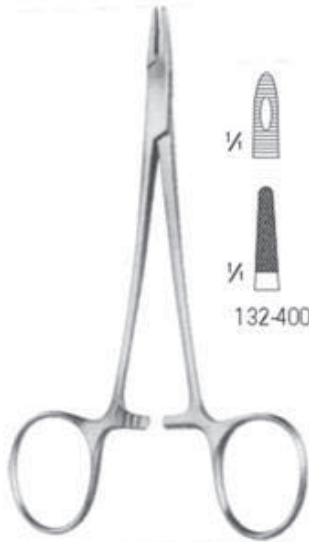

G14-15
 Derf Needle Holder 4 3/4"



G14-18
 Olsen Hegar Needle Holder
 4 3/4" Delicate



G14-12
 Olsen Hegar Needle Holder 5 1/2"

G14-13
 Olsen Hegar Needle Holder 6 1/2"

GerVetUSA
 The Complete Shop of Surgical Instruments



GD50-2014
 Castroviejo offset Micro Surgical
 Needle Holder 5 1/2" Serrated,
 Tungsten Carbide



G14-20
 Boynton Needle Holder 4 3/4"



G14-43
 Mayo Hegar Needle Holder 5 1/4"

G14-03
 Mayo Hegar Needle Holder 6"



G14-27
 Crile Needle Holder, 6"

Needle Holders-Tungsten Carbide



GD50-2099
Plier Type Needle Holders,
Tungsten Carbide Insert



G17-154
Castroviejo Needle Holders,
With Lock, Straight, Serrated,
5 1/2", Tungsten Carbide

G17-156
Castroviejo Needle Holder,
Curved, Serrated with Lock,
Tungsten Carbide, 5 1/2"



GD50-2011
Castroviejo Micro Surgical Needle
Holder 5 1/2" Serrated, Straight With
Catch, Round Body Style, Tungsten

GD50-2012
Castroviejo Micro Surgical Needle
Holder 5 1/2" Serrated, Curved With
Catch, Round Body Style, Tungsten



GerVetUSA
The Complete Shop of Surgical Instruments



G17-43
Crile Wood Needle Holder,
Tungsten Carbide Jaws,
Serrated, 6"



G17-83
Derf Needle Holder, Serrated,
4 3/4", Tungsten Carbide



G17-128
Olsen Hegar Needle Holder 4
3/4" Delicate, Tungsten Carbide



G17-68
Olsen Hegar Needle Holder 5
1/2", Tungsten Carbide

G17-55
Olsen Hegar Needle Holder
6 1/2", Tungsten Carbide

GerVetUSA™
Animal Care at the Highest Quality

Needle Holders-Tungsten Carbide



G17-93
Mathieu Olsen Hegar Needle
Holder 6 3/4" Tungsten Carbide

G17-94
Mathieu Olsen Hegar Needle
Holder 5 1/2" Tungsten Carbide



G17-90
Mathieu Needle Holder 5 1/2"
Tungsten Carbide

G17-52
Mathieu Needle Holder 6 1/4"
Tungsten Carbide



G17-65
Mathieu Lichtenberg Needle
Holder 6 1/2" Tungsten Carbide

G17-60
Mathieu Lichtenberg Needle
Holder 5 1/2" Tungsten Carbide



G17-61
Boynton Needle Holder 4 3/4"
Tungsten Carbide



G17-160
Mayo Hegar Needle Holder,
Serrated, 5", Tungsten Carbide

G17-45
Mayo Hegar Needle Holders,
Serrated, 6", Tungsten Carbide



G17-140
Mini Ryder Needle Holder 5",
Tungsten Carbide

G17-70
Mini Ryder Needle Holder 6",
Tungsten Carbide

G17-71
Mini Ryder Needle Holder 7
1/4", Tungsten Carbide

GerVetUSA™
Animal Care at the Highest Quality

Forceps



GD50-12-20
Tartar Remover Forceps 4 3/4"



GD50-1406
Rabbit Molar Forceps



G11-03
Kelly Hemostatic Forceps
5 1/2" Straight

G11-04
Kelly Hemostatic Forceps
5 1/2" Curved



G11-01
Halstead Mosquito Forceps
4 3/4" Straight

G11-02
Halstead Mosquito Forceps
4 3/4" Curved

GerVetUSA

The Complete Shop of Surgical Instruments



G22-78
Hartman Hemostatic Forceps
3 1/2" Straight

G22-79
Hartman Hemostatic Forceps
3 1/2" Curved



G12-21
Adson Dressing Forceps
4 3/4" Serrated



G12-22
Adson Tissue Forceps
4 3/4" 1x2th



G18-151
Bishop Harmon Forceps
3 1/4" Serrated



G18-150
Bishop Harmon Forceps
3 1/4", 1x2th

Extracting Forceps

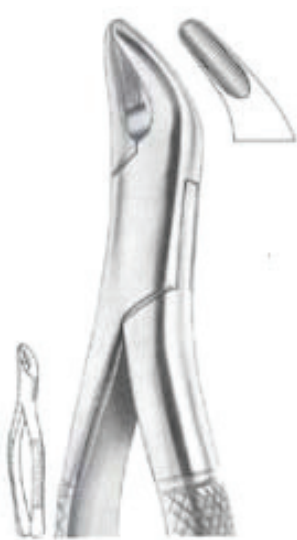

GD50-46
Dental Standard Extracting Forceps #62



GD50-1218
Dental Extracting Forceps Universal, Witzel, DEF116



GD50-1219
Dental Extracting Forceps Universal, Witzel, DEF120



GD50-75
Dental Extracting Forceps, F, Pedo Upper Root, Universal, Mini

GerVetUSA

The Complete Shop of Surgical Instruments



GD50-12
Dental Extracting Forceps, 1st and 2nd Molar, Left, 18L



GD50-70
Dental Extracting Forceps, A, Pedo Upper Molar, Universal, Mini



GD50-71
Dental Extracting Forceps, B, Pedo Lower Root, Universal, Mini



GD50-73
Dental Extracting Forceps, E, Pedo Upper Front, Mini

Extracting Forceps



GD50-74
Dental Extracting Forceps,
F, Pedro Upper Root,
Universal, Mini



GD50-41
Dental Extracting Forceps,
Lower Incisors, Cuspids,
and Bicuspid and Roots,
Universal, 151



GD50-47
Dental Extracting Forceps,
Upper and Lower Bicuspid
and Deciduous, Universal, 101



GD50-49
Dental Extracting Forceps,
Upper and Lower Fragments
and Roots, 69

GerVetUSA The Complete Shop of Surgical Instruments



GD50-48
Dental Extracting Forceps,
Upper and Lower Splitting
and Separating, 6



GD50-39
Dental Extracting Forceps,
Upper Anterior, Split Beaks,
Serrated, 150AS

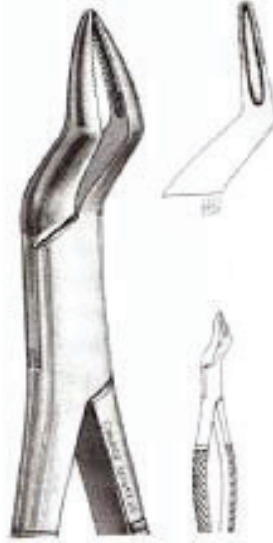

GD50-40
Dental Extracting Forceps,
Upper Bicuspid, Incisors and
Roots, 286



GD50-37
Dental Extracting Forceps, Upper
Incisors, Cuspids and Bicuspid
and Roots, Universal, 150

Extracting Forceps



GD50-34
Dental Extracting Forceps,
Upper Incisors, Henahan, 1HEN



GD50-72
Dental Extracting Forceps, C, Pedro
Lower Molars, Universal, Mini



GD50-16
Dental Extracting Forceps,
32A Finer Tip



GD50-332
Paronychia Extraction Forceps 32A

GerVetUSA The Complete Shop of Surgical Instruments



GD50-51
Standard Extracting Forceps #1



GD50-61
Universal Extracting Forceps 17S



GD50-66
Universal Extracting Forceps, 150S



GD50-67
Universal Extracting Forceps, 151S

Extracting Forceps



GD50-1481
Dental Root Extracting Forceps
#333S



GD50-1482
Dental Root Extracting Forceps
#351S



GD50-1483
Dental Root Extracting Forceps
#300, Curved Handle



GD50-1484
Dental Root Extracting Forceps
#301, Straight Handle

GerVetUSA

The Complete Shop of Surgical Instruments



GD50-1485
Dental Root Extracting Forceps
#46, Straight Handle



GD50-1486
Dental Root Extracting Forceps #46L



GD50-1487
Dental Root Extracting Forceps #4658



GD50-1488
Dental Root Extracting Forceps #648I

Extracting Forceps



GD50-1489
Dental Root Extracting
Forceps #9050



GD50-1168
Peets Dental Root
Extracting Forceps 4 3/4"



GD50-2096
Extraction Forceps,
Right Angled



GD50-2097
Root Tip Extraction
Forceps 6"



GD50-2098
Fragment Root Extraction
Forceps 5 1/2"

Retractors

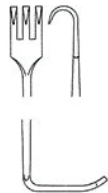

G13-38
Senn Miller Retractor 3 Prongs Sharp 6 1/4"
G13-39
Senn Miller Retractor 3 Prongs Blunt 6 1/4"



GD50-1459
Feline Tissue Retractor



GD50-1460
Tongue Depressor Retractor

Retractors



GD50-1461
Prichard Retractor L/R



GD50-1462
Kirkland Tissue Retractors, 1, Sharp



GD50-1463
Kirkland Tissue Retractors, 2, Sharp



GD50-1464
Kirkland Tissue Retractors, 3, Sharp



GD50-1465
Kirkland Tissue Retractors, 4, Sharp



GD50-1466
Kirkland Tissue Retractors, 5, Sharp



GD50-1467
Kirkland Tissue Retractors, 1, Dull



GD50-1468
Kirkland Tissue Retractors, 2, Dull

Retractors



GD50-1469
Kirkland Tissue Retractors, 3, Dull



GD50-1470
Kirkland Tissue Retractors, 4, Dull



GD50-1471
Kirkland Tissue Retractors, 5, Dull

GerVetUSA

The Complete Shop of Surgical Instruments

Rongeur

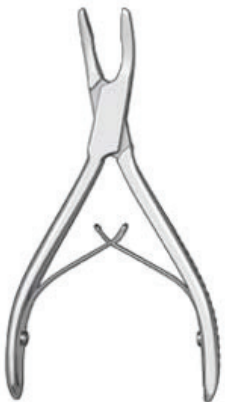

GD50-150
Friedman Dental Rongeur
5 1/2", Curved & Delicate

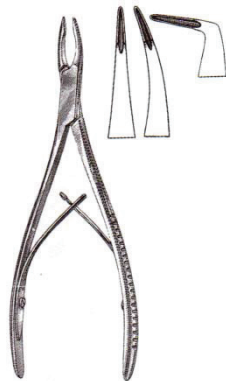

GD50-151
Micro Friedman Dental
Rongeur 5 1/2", Slightly
Curved



G24-350
Dean (Blumenthal) Rongeur,
6", 3 x 10mm bite tapered
to 4mm, Slightly curved jaw



G24-706
Stellbrink Rongeur 6 3/4",
2mm Tip, 45 Degree Angle



G24-707
Stellbrink Rongeur 6 3/4",
2mm Tip, 30 Degree Angle

Dental Packs



V2001-12

- Advanced Rabbit Dental Pack
- 1 **G19-76** Lempert-Rongeur
 - 1 **V70-265** Rabbit Mouth Gag
 - 1 **G22-15** Lewis rabbit Dental Rasp
 - 1 **G46-25-01** Hollman Mouth Spatula
 - 1 **G46-25-02** Hollman Mouth Spatula
 - 1 **G21-20-01** Cheek Gag, Large
 - 1 **G21-20-02** Cheek Gag, Small
 - 1 **GD50-950** Crossley Luxator#1
 - 1 **GD50-951** Crossley Luxator#2
 - 1 **GD50-2084** Molar Cutters



V2001-13

- Basic Rabbit Dental Pack
- 1 **G19-76** Lempert Rongeur
 - 1 **V70-265** Rabbit Mouth Gag
 - 1 **G22-328-01** Rasp
 - 1 **GD50-2083** Large Mouth Spatula
 - 1 **GD50-2055** Small Mouth Spatula
 - 1 **G21-20-02** Large Cheek Gag
 - 1 **G21-20-02** Small Check Gag
 - 1 **GD50-2084** Molar Cutters



GD50-14-05

Luxating Elevators Set of 6,
Extra Short, 2mm Back Curved, 2mm Inside
Curved, 2mm Straight, 3mm Back Curved,
3mm Inside Curved, 3mm Straight

- 1 **GD40-21** Luxating Elevator 2mm Back Blade
- 1 **GD40-19** Luxating Elevator 2mm Inside Blade
- 1 **GD40-13** Luxating Elevator 2mm Straight
- 1 **GD40-23** Luxating Elevator 3mm Back Blade
- 1 **GD40-24** Luxating Elevator 3mm Inside Blade
- 1 **GD40-14** Luxating Elevator 3mm Straight Blade



GD50-20-04

Winged Elevator Set- Large Handle, 2,3,4,5,6,7 and 8mm

- 1 **GD50-197** Winged Elevator #2 Long Handle
- 1 **GD50-198** Winged Elevator #3 Long Handle
- 1 **GD50-199** Winged Elevator #4 Long Handle
- 1 **GD50-180** Winged Elevator #5 Long Handle
- 1 **GD50-181** Winged Elevator #6 Long Handle
- 1 **GD50-182** Winged Elevator #7 Long Handle
- 1 **GD50-183** Winged Elevator #8 Long Handle
- 1 **GD50-361** Sterilizer Cassette for Kit



Dental Packs



GD50-500

Winged Elevator
With Removable Handle Set of Four, 2mm, 3mm, 4mm and 5mm

- 4 **GD50-501** Winged Elevator #2 Removable Handle
- 4 **GD50-502** Winged Elevator #3 Removable Handle
- 4 **GD50-503** Winged Elevator #4 Removable Handle
- 4 **GD50-504** Winged Elevator #5 Removable Handle
- 1 **GD50-508** Winged Elevator Handle
- 1 **GD50-509** Mini Tightening Ratchet



GD50-20-02

Winged Elevators Set- Small
Handle Set of, 2,3,4,6 & 8 mm

- 1 **GD50-190** Winged Elevator #2mm Short Handle
- 1 **GD50-191** Winged Elevator #3mm Short Handle
- 1 **GD50-192** Winged Elevator #4mm Short Handle
- 1 **GD50-193** Winged Elevator #5mm Short Handle
- 1 **GD50-194** Winged Elevator #6mm Short Handle



GD50-700

Basic Dental Prophesy Set
Choice of one Mouth Mirror #3, #4 or #5

- 1 **G21-06-03** Mouth Mirror #3
- 1 **G21-06-04** Mouth Mirror #4
- 1 **G21-06-05** Mouth Mirror #5
- 1 **GD50-740** Probe/Explorer ,Combination Markings 3,6,9,12,15 & 18mm
- 1 **GD50-830** Towner-Jacquette Scaler U15/J30
- 1 **GD50-840** Jacquette Scaler 31/32
- 1 **GD50-900** McCall Scaler 13S/14S



GD50-1000

Feline Scaler-Curette Kit

- 1 **GD50-902** Interproximal Scaler Double Ended
- 1 **GD50-157** Feline Gracey Curette 1/2
- 1 **GD50-752** Feline Gracey Curette 5/6
- 1 **GD50-755** Feline Gracey Curette 11/12
- 1 **GD50-813** Feline Gracey Curette 11/14

Dental Packs

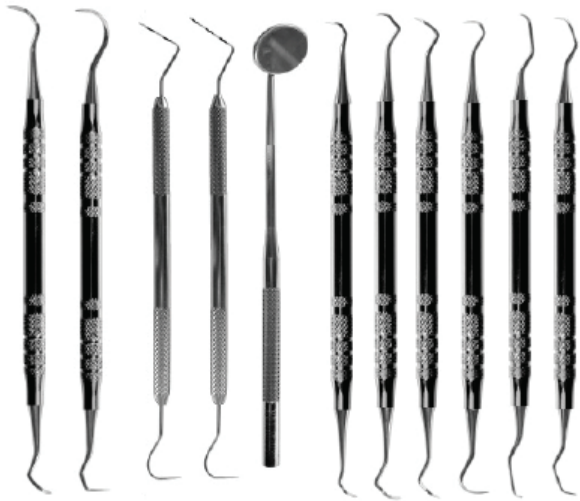

GD50-700B

Advanced Prophy Kit

Choice of one Mouth Mirror #3, #4 or #5

1 **GD21-06-03** Mouth Mirror #3

GD21-06-04 Mouth Mirror #4

GD21-06-05 Mouth Mirror #5

1 **GD50-740** Probe/Explorer Markings, 3,6,9,12,15 & 18mm

1 **GD50-750** Probe/Explorer Markings, 3,6,9 & 12

1 **GD50-830** Towner-Jacquette Scaler, U15-J30

1 **GD50-840** Jacquette Scaler J31/J32

1 **GD50-929** Jacquette Scaler J34/J35

1 **GD50-758** Columbia Curette 13/14

1 **GD50-902** Interproximal Scaler 204S

1 **GD50-803** Jacquette Sickle Scaler, JH5/J33

1 **GD50-157** Feline Gracey Curette 1/2

1 **GD50-752** Gracey Curette 3/4

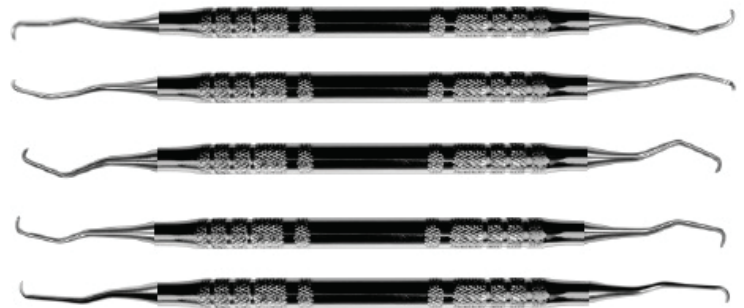

GD50-1010

Feline Curette Kit

1 **GD50-80** Feline Curette

1 **GD50-81** Feline Curette Gracey 1/2

1 **GD50-82** Feline Curette Gracey 7/8

1 **GD50-83** Feline Curette Gracey 11/12

1 **GD50-84** Feline Curette Gracey 13/14



GD50-336

Basic Exodonita Kit

1 **GD50-133** Periosteal Elevator Molt#9

1 **GD50-327** Miller Curette #10

1 **GD50-330** Seldin Surgical Elevator 34S

1 **GD50-331** Surgical Elevator# 301-Apexo Equivalent

1 **GD50-332** Parmlly Surgical Elevator 32A



GD50-337

Feline Elevator Kit

1 **GD50-340** Surgical Elevator #46, Medium Curved

1 **GD50-341** Howard Surgical Elevator 1

1 **GD50-342** Surgical Root Elevator #100

1 **GD50-343** Surgical Root Elevator#100R

1 **GD50-116** Cryer Surgical Elevator #44

1 **GD50-117** Cryer Surgical Elevator #45

GerVetUSA™
Animal Care at the Highest Quality

Dental Packs



GD50-350

Advanced Feline Elevator Kit

- 1 **GD50-338** Surgical Feline Elevator100G
- 1 **GD50-340** Surgical Feline Elevator #5
- 1 **GD50-77** Holmstrom Elevator 5H
- 1 **GD50-344** Surgical Feline Elevator #15
- 1 **GD50-345** Surgical Feline Elevator#16
- 1 **GD50-123** Heidbrink Surgical Root Tip
- 1 **GD50-130** West Surgical Feline
- 1 **GD50-130** Periosteal Elevator DEL W2



GD50-366

Winged Elevator Back-Bent Kit

- 1 **GD50-362** Winged Elevator 1mm Back Bent Style,
- 1 **GD50-363** Winged Elevator 2mm Back Bent Style
- 1 **GD50-364** Winged Elevator 3mm Back Bent Style
- 1 **GD50-365** Winged Elevator 4mm Back Bent Style



GD50-385

Winged Elevator Kit

- 1 **GD50-382** Winged Elevator Curette Style, Ends are 1mm/2mm
- 1 **GD50-383** Winged Elevator Curette Style, Ends are 3mm/4mm
- 1 **GD50-384** Winged Elevator Curette Style, Ends are 6mm/8mm

GerVetUSA™
Animal Care at the Highest Quality

For Details Call: 516-385-3434

Toll Free: 888-814-4650

Fax: 516-358-2182

Toll Free Fax: 888-600-0310

Email: sales@GerVetUSA.com

Website: www.GerVetUSA.com

Address: 1188 Willis Avenue

#801 Albertson, NY 11507

Dental Packs



GD50-380

Winged Elevator Inside-Bent Kit

- 1 **GD50-370** Winged Elevator Inside-Bent 1mm
- 1 **GD50-371** Winged Elevator Inside-Bent 2mm
- 1 **GD50-372** Winged Elevator Inside-Bent 3mm
- 1 **GD50-373** Winged Elevator Inside-Bent 4mm

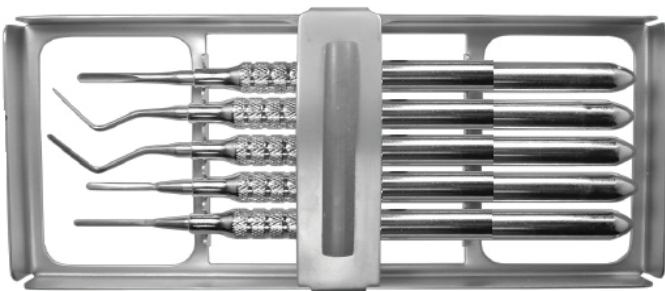

GD50-1441

GerMed Periostomes Kit

- 1 **GD50-1436** GerMed Periostome #1
- 1 **GD50-1437** GerMed Periostome #2
- 1 **GD50-1438** GerMed Periostome #3
- 1 **GD50-1439** GerMed Periostome #4
- 1 **GD50-1440** GerMed Periostome #5



GD50-1411

Rabbit Extraction Kit
Choice of three Long or Short Handle Root Elevators

- 1 **GD50-1408** Root Elevator 1.3mm, 3G, LongHandle
 - 1 **GD50-1409** Root Elevator 1.3mm, 31G, Long Handle
 - 1 **GD50-1410** Root Elevator 1.3mm, 30G, Long Handle
- OR**

- 1 **GD50-352** Root Elevator 1.3mm, 3G, Short Handle
- 1 **GD50-353** Root Elevator 1.3mm, 31G, Short Handle
- 1 **GD50-354** Root Elevator 1.3mm, 30G, Short Handle
- 1 **GD50-950** Crossley Luxation Instrument #1
- 1 **GD50-951** Crossley Luxation Instrument #2
- 1 **GD50-1406** Rabbit Molar Forceps
- 1 **G21-20-02** Cheek Dilator, Small
- 1 **G21-20-01** Cheek Dilator, Large
- 1 **V70-265** Mouth Gag



GD50-2020

Holmstrom Plugger/Spreaders Kit

- 1 **GD50-2021** Holmstrom Plugger/Spreaders Ends, 26mm, Style 20
- 1 **GD50-2022** Holmstrom Plugger/Spreaders Ends, 26mm, Style 35
- 1 **GD50-2023** Holmstrom Plugger/Spreaders Ends, 42mm, Style 50
- 1 **GD50-2024** Holmstrom Plugger/Spreaders Ends, 42mm, Style 65
- 1 **GD50-2025** Holmstrom Plugger/Spreaders Ends, 42mm, Style 90

Dental Packs

GD50-2089

General Purpose Dental Set Short Handle

- 1 **GD50-190** Winged Elevator #2mm Short Handle
- 1 **GD50-191** Winged Elevator #3mm Short Handle
- 1 **GD50-192** Winged Elevator #4mm Short Handle
- 1 **GD50-193** Winged Elevator #5mm Short Handle
- 1 **GD50-194** Winged Elevator #6mm Short Handle
- 1 **GD50-1305** Root Tip Pick, Straight
- 1 **GD50-12-20** Tartar Removal Forceps
- 1 **GD50-67** Universal Extraction Forceps 151S
- 1 **GD50-1458** Minnesota Cheek Retractor
- 1 **GD50-758** Columbia Curette 13-14 Fine
- 1 **GD50-789** Jacquette Supragingival Scaler 20/33
- 1 **GD50-803** Sickle Scaler
- 1 **GD50-303-1** Dental Explorer and Graduated Probe, D/E style PE1-23
- 1 **GD50-129** Freer Periosteal Elevator, Double Ended



GD50-2090

General Purpose Dental Set Long Handle

- 1 **GD50-197** Winged Elevator #2mm Long Handle
- 1 **GD50-198** Winged Elevator #3mm Long Handle
- 1 **GD50-199** Winged Elevator #4mm Long Handle
- 1 **GD50-180** Winged Elevator #5mm Long Handle
- 1 **GD50-181** Winged Elevator #6mm Long Handle

Long Handle Winged Elevator General Dental Set Also Available



GD50-2092

Feline Periodontal Kit

- 1 **GD50-352** Feline Elevator, Extra Short 3S
- 1 **GD50-353** Feline Elevator, Extra Short 31G
- 1 **GD50-2018** DeForge Feline Periosteal Probe, Markings 1, 2, 3, 5, 7, 8, 9 & 10mm
- 1 **GD50-2091** Resorptive Lesion Probe
- 1 **GD50-04** Sickle Scaler N-135
- 1 **GD50-758** Curette Columbia 13-14 Fine TTDE
- 1 **GD50-74** Dental Extracting Forceps, F, P, Upper Root, Universal, Mini

GD50-2100

Specialized Instrument Set

- 1 **GD50-133** Molt 9 Periosteal Elevator
- 1 **GD50-2093** Deciduous Elevator 2mm Curved
- 1 **GD50-2094** Deciduous Elevator 3mm Curved
- 1 **GD50-2095** Deciduous Elevator 4mm Curved
- 1 **GD50-2096** Extraction Forceps, Right Angled

GerVetUSA™
Animal Care at the Highest Quality

Dental Trays

GerVetUSA™
Animal Care at the Highest Quality

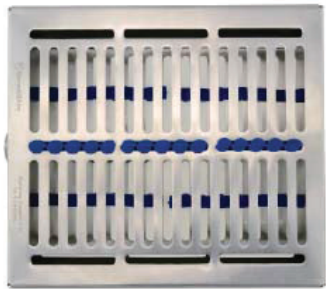

GD50-1480

Sterilization Tray for Dental Instruments, Holds up to 6 Instruments

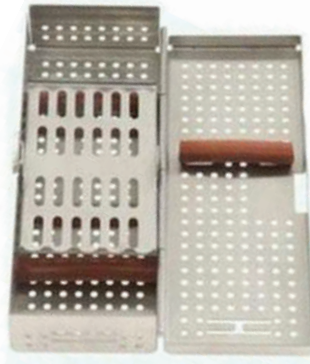

GD50-3000

Sterilization Tray for Dental Instruments, Holds up to 5 Instruments



GD50-3030

Sterilization Tray for Dental Instruments, Holds up to 20 Instruments



GD50-3020

Sterilization Tray for Dental Instruments, Holds up to 16 Instruments

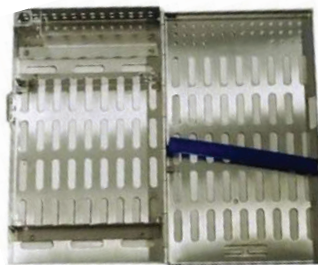

GD50-3010

Sterilization Tray for Dental Instruments, Holds up to 12 Instruments

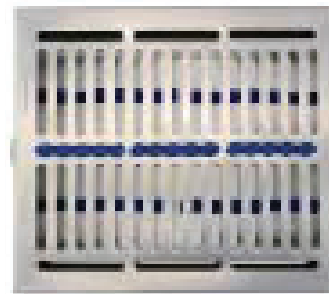

GD50-361

Sterilizer Winged Elevator Cassette



GD50-557

Sterilizer, Needle, Spiral Rack

GerVetUSA™
Animal Care at the Highest Quality

For Details Call: 516-385-3434

Toll Free: 888-814-4650

Fax: 516-358-2182

Toll Free Fax: 888-600-0310

Email: sales@GerVetUSA.com

Website: www.GerVetUSA.com

Address: 1188 Willis Avenue
#801 Albertson, NY 11507



GerVetUSA™

Animal Care at the Highest Quality

G09-00

Siegel Round Knife Handle #5



GD-5212

Elevator Double Ended G9x



VGD50-20-19

Winged Elevator Set-Small Handle with



G12-22

Adson Tissue Forceps 4 3/4" 1x2th



G10-45

Iris Scissors Curved 4 1/2" With Sharp Tips



G14-43

Mayo Hegar Needle Holder 5 1/4"



GerVetUSA

The Complete Shop of Surgical Instruments

GerVetUSA™

Animal Care at the Highest Quality

GD50-4234-LRG

Atraumatic Forceps, PEDO, Upper Universal, F1



GD50-3010

Sterilization Tray for Dental Instruments, Holds up to 10 Instruments
NEW Style 79.95 | [Sale 49.95](#)



GD50-3030

Sterilization Tray for Dental Instruments, Holds up to 20 Instruments
NEW Style 149.00 | [Sale 89.95](#)

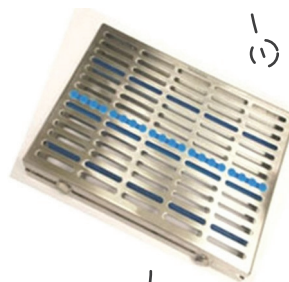

VGD50-361

Sterilizing Tray Holds 8 Dental Elevators
NEW Style 89.95 | [Sale 59.95](#)

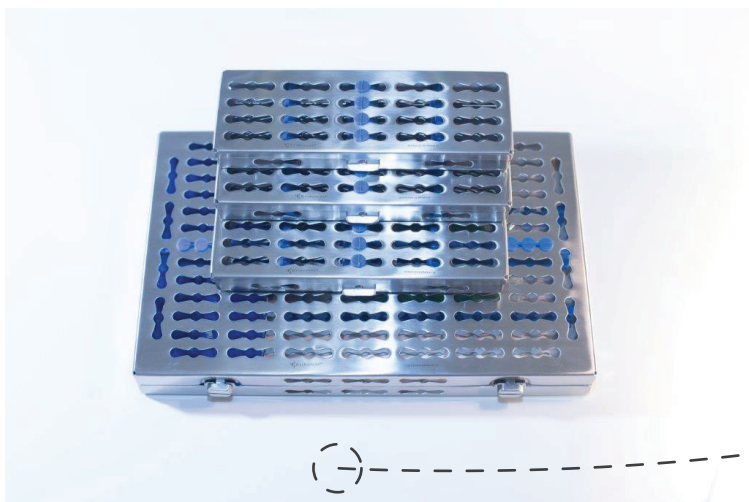
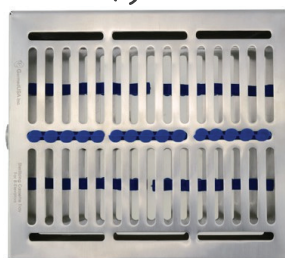

GerVetUSA™
Animal Care at the Highest Quality

For Details Call: 516 593 7100

Toll Free: 888 814 4650

Fax: 516 593 7400

Toll Free Fax: 888-814 4776

Email: sales@GerVetUSA.com

Website: www.GerVetUSA.com

Address: 2417 Jericho Turnpike,
#333 Garden City Park, NY 11040.

GerVetUSA™

Animal Care at the Highest Quality



Olsen Hegar Needle Holder 5 1/2",
Tungsten Carbide
Price: \$115.86

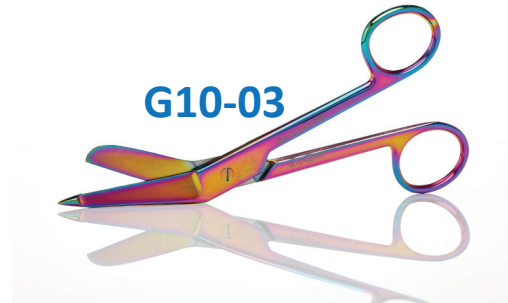

Rainbow Color Coated, Lister Bandage
Scissors, 5 1/2"
Price: \$40.53



Lister Bandage Scissors 7 1/4" Supercut
Regular Price: \$90.95



Beckman-Weitlaner Retr. 3x4 Sharp,
Hinged BI 5 1/2"
Regular Price: \$318.91



Mycotic Nail Nipper, Double Action Jaws,
Barrel Spring, Straight, 6"
Regular Price: \$70.96



Northbent Stitch Scissors
G10-42A-RT | G10-42A-B | G10-42A-GM
Regular Price: \$61.28

GerVetUSA™

Animal Care at the Highest Quality

VGD50-3030, VGD50-3010, VGD50-361



Sterilization Tray for Dental Instruments
Holds up to 20 Instruments

GerVetUSA

The Complete Shop of Surgical Instruments



Scan to watch our tutorial

Why should you buy from us?

*Because we not only sell, but
also manufacture our own
surgical instruments...*

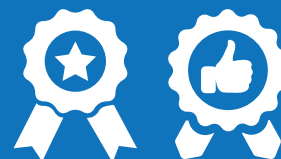

GerVetUSA™
Animal Care at the Highest Quality

GerVetUSA
*The Complete Shop of
Surgical Instruments*



Scan to watch our tutorial

For Details Call: 516-385-3434

Toll Free: 888-814-4650

Fax: 516-358-2182

Toll Free Fax: 888-600-0310

Email: sales@GerVetUSA.com

Website: www.GerVetUSA.com

Address: 1188 Willis Avenue
#801 Albertson, NY 11507



INDEX

A

Adson Dressing Forceps 4 3/4" Serrated.....	36
Adson Tissue Forceps 4 3/4" 1x2th.....	36
Advanced Feline Elevator Kit.....	47
Advanced Prophyl Kit.....	46
Advanced Rabbit Dental Pack.....	44
Apexo Surgical Elevator #301.....	23
Apical Del 303 Elevator, 5 3/4".....	24

B

Barnhart Curette 5/6.....	8
Barnhart Curette 5/6, Cut Back, Feline Curette.....	8
Basic Dental Prophyl Set.....	45
Basic Exodontia Kit.....	46
Basic Rabbit Dental Pack.....	44
Bishop Harmon Forceps 3 1/4" Serrated.....	36
Bishop Harmon Forceps 3 1/4", 1x2th.....	36
Black Amalgam Plugger 1/2.....	27
Black Amalgam Plugger 2/3.....	27
Bone Curette, Double Ended, 3mm/3mm, Straight.....	10
Bone Curettes, Molt, No. 1.....	10
Bone Curettes, Molt, No. 2.....	10
Bone Curettes, Molt, No. 2/4, Double Ended.....	10
Bone File #10, Double Ended.....	13
Bone File #33, Double Ended.....	13
Boynton Needle Holder 4 3/4".....	33
Boynton Needle Holder 4 3/4" Tungsten Carbide.....	35

C

Cameron Dental Elevator.....	16
Canine Double Ended Elevator.....	16
Canine Mouth Gag Large Size 6 3/4".....	3
Canine Mouth Gag Medium Size 5 3/4".....	3
Canine Mouth Gag Small Size 4".....	3
Canine Probe, 3,6,9,12,15 & 18mm, Style 1.....	10
Canine Probe, 3,6,9,12,15 & 18mm, Style Two.....	10
Castroviejo Micro Periodontal Scissors 3 1/2".....	30
Castroviejo Micro Periodontal Scissors 5 1/2".....	30
Castroviejo Micro Surgical Needle Holder 5 1/2" Serrated, TC.....	34
Castroviejo Micro Surgical Needle Holder 5 1/2" Serrated.....	32
Castroviejo Micro Surgical Needle Holder 5 1/2" Round, TC.....	34
Castroviejo Needle Holder, 5 1/4", Straight Jaw With Catch.....	32
Castroviejo Needle Holder, Curved, with Lock, TC, 5 1/2".....	34
Castroviejo Needle Holders, With Lock, Straight, 5 1/2", T.....	34
Castroviejo Offset Micro Surgical Needle Holder 5 1/2".....	32
Castroviejo Offset Micro Surgical Needle Holder 5 1/2", TC.....	33
Chandler Bone Chisel #1.....	5

Chandler Bone Chisel #2.....	5
Chandler Bone Chisel #3.....	5
Chandler Bone Chisel #4.....	5
Chandler Bone Chisel #5.....	5
Chandler Bone Chisel #6.....	5
Cheek Dilator, Large.....	3
Cheek Dilator, Long Reach, Curved 40mm.....	3
Cheek Dilator, Small.....	3
Columbia Curette 13-14 Fine, Double Ended.....	8
Columbia Curette 4L-4R TTDE, Feline Universal Curette.....	8
Composite Instrument Style 11.....	28
Composite Instrument Style 16.....	28
Composite Instrument Style 17.....	28
Composite Instrument Style 18.....	28
Composite Instrument Style 2.....	28
Composite Instrument Style 4.....	28
Composite Instrument Style 5.....	28
Composite Instrument Style 6.....	28
Composite Instrument Style 6X.....	28
Composite Instrument Style 7.....	28
Composite Instrument Style 9.....	28
Corn Luxation Instrument.....	24
Crile Needle Holder, 6".....	33
Crile Wood Needle Holder, Tungsten Carbide Jaws, 6".....	34
Crossley Luxation Exdantia Instrument #1.....	24
Crossley Luxation Exdantia Instrument #2.....	24
Crossley Luxation Exdantia Instrument #3.....	24
Crossley Luxation Exdantia Instrument #4.....	24
Cryer Elevator #21.....	15
Cryer Elevator #22.....	15
Cryer Surgical Elevator #44.....	15
Cryer Surgical Elevator #45.....	15
Curette Style H6/7.....	9

D

Davis Root Tip Teaser 10, Serrated.....	6
Davis Root Tip Teaser 10, Smooth.....	6
Davis Root Tip Teaser 11, Serrated.....	6
Davis Root Tip Teaser 11, Smooth.....	6
Dean Scissors 6 3/4" Straight, One Serrated Blade.....	30
Dean (Blumenthal) Rongeur, 6", 3 x 10mm 4mm.....	43
Deciduous Elevator ,D/E, 2mm/2mm Ends, Curved.....	19
Deciduous Elevator ,D/E, 3mm/3mm Ends, Curved.....	19
Deciduous Elevator ,D/E, 3mm/3mm Ends, Straight.....	19
Deciduous Elevator, Curved 2mm, Small.....	19
Deciduous Elevator, Curved 3mm, Medium.....	19

INDEX

Deciduous Elevator, Curved 4mm, Large	19
Deciduous Elevator,D/E,, 4mm/4mm Ends, Curved, Forward	19
Deciduous Elevator,D/E,, 5mm/5mm Ends, Straight	19
Deluxe Mirror Handle Cone Socket	28
Deluxe Mirror Handle Octagonal Cone Socket	28
Dental Burnisher #21B.....	12
Dental Burnisher #27/29.....	12
Dental Burnisher #2DE.....	12
Dental Cleoid Discoid #1/2, Small.....	19
Dental Cleoid Discoid #3/6, Large.....	19
Dental Cleoid Discoid #89/92, Medium.....	19
Dental Elevator #301.....	16
Dental Elevator #302.....	16
Dental Elevator #303.....	16
Dental Elevator #304.....	16
Dental Elevator #305.....	16
Dental Elevator #306.....	16
Dental Elevator #307.....	16
Dental Elevator #308.....	16
Dental Elevator #309.....	16
Dental Elevator #34 Heavy.....	16
Dental Elevator #5.....	14
Dental Elevator #77.....	16
Dental Elevator #77R.....	16
Dental Elevator 100G.....	14
Dental Excavator #17.....	12
Dental Excavator #18.....	12
Dental Excavator #19.....	12
Dental Excavator #31L.....	12
Dental Explorer 2D.....	10
Dental Explorer and Graduated Probe, D/E style PE1-23.....	11
Dental Explorer, 17	11
Dental Explorer, Style 7.....	11
Dental Explorer,style 3A	11
Dental Extracting Forceps Universal, Witzel, DEF116.....	37
Dental Extracting Forceps Universal, Witzel, DEF120.....	37
Dental Extracting Forceps, F, Pedo Upper Root, Universal, Mini.....	37
Dental Extracting Forceps, 1st and 2nd Molar, Left, 18L.....	37
Dental Extracting Forceps, 32A Finer Tip.....	39
Dental Extracting Forceps, A, Pedo Upper Molar, Mini	37
Dental Extracting Forceps, B, Pedo Lower Root, Mini.....	37
Dental Extracting Forceps, E, Pedo Upper Front, Mini.....	37
Dental Extracting Forceps, F, Pedo Upper Root,, Mini.....	38
Dental Extracting Forceps, Lower Incisors,151.....	38
Dental Extracting Forceps, Upper and Lower, 101.....	38
Dental Extracting Forceps, Upper and Lower 69	38
Dental Extracting Forceps, Upper and Lower Splitting, 6.....	38
Dental Extracting Forceps, Upper Anteriors,, 150AS.....	38
Dental Extracting Forceps, Upper Bicuspid, 286.....	38
Dental Extracting Forceps, Upper Incisors, Cuspids, 150.....	38

Dental Extracting Forceps, 1HEN	39
Dental Extracting Forceps,C, Universal, Mini	39
Dental Root Extracting Forceps #300, Curved Handle	40
Dental Root Extracting Forceps #301, Straight Handle	40
Dental Root Extracting Forceps #333S	40
Dental Root Extracting Forceps #351S	40
Dental Root Extracting Forceps #46, Straight Handle	40
Dental Root Extracting Forceps #4658	40
Dental Root Extracting Forceps #46L	40
Dental Root Extracting Forceps #648L	40
Dental Root Extracting Forceps #9050	41
Dental Standard Extracting Forceps #62	37
Dental Wax Carver #1/2	28
Dental Wax Carver #3S	28
Derf Needle Holder 4 3/4"	33
Derf Needle Holder, Serrated, 4 3/4", Tungsten Carbide	34

E

Eisner Elevator 5E	14
Eisner Holmstrom Modified Elevator 5EH	14
Excavator Style #33L	12
Excavator Style #38/39	12
Excavator Style #61/62	12
Explorer Endo DG-16, Double Ended	11
Explorer TU17/23, Double Ended	11
Extraction Forceps 32A	39
Extraction Forceps, Right Angled	41

F

Fedi Periodontal Bone Chisel #1	5
Fedi Periodontal Bone Chisel #2	5
Feline Curette Kit	46
Feline Curette, Double Ended 0	8
Feline Double Ended Elevator	16
Feline Elevator Kit	46
Feline Elevator, Extra Short 100G	15
Feline Elevator, Extra Short 15	15
Feline Elevator, Extra Short 16	15
Feline Elevator, Extra Short 3	15
Feline Elevator, Extra Short 30G	15
Feline Elevator, Extra Short 31G	15
Feline Elevator, Extra Short 3S	15
Feline Elevator, Extra Short 4	15
Feline Elevator, Extra Short 5	15
Feline Elevator, Extra Short 5H	15

INDEX

Feline Gracey 1/2 Curette, Double Ended	8
Feline Gracey 11/12 Curette, Double Ended	8
Feline Gracey 13/14 Curette, Double Ended	9
Feline Gracey 7/8 Curette, Double Ended	8
Feline Mouth Gag Light Weight 3"	3
Feline Periodontal Kit	49
Feline Periosteal Probe, 1,2,3,5,7,8,9 & 10mm Style One	10
Feline Periosteal Probe, 1,2,3,5,7,8,9 & 10mm Style Two	10
Feline Petite Mouth Gag light Weight 2 1/4".....	3
Feline Scaler-Curette Kit	45
Feline Surgical Elevator #46	15
Feline Tissue Retractor	41
Feline/Canine Periosteal Elevator, Double Ended 2/2	16
Finger Plugger Handle Only, Double Ended	26
Finger Plugger Handle Only, Single End	26
Fragment Root Extraction Forceps 5 1/2".....	41
Freer Nasal Periosteal Elevator	18
Freer Periosteal Elevator 15G	18
Freer Periosteal Elevator 15G, Mini	18
Freer Periosteal Elevator 16G, One bent end	18
Freer Periosteal Elevator 16G, One bent end, Mini	18
Freer Periosteal Elevator, Double Ended	18
Freer Periosteal Elevator, Double Ended, Long Handle	18
Friedman Dental Rongeur 5 1/2", Curved & Delicate	43

G

General Purpose Dental Set-Long Handle	49
General Purpose Dental Set-Short Handle	49
GerMed Periosteal Elevator 10	18
GerMed Periosteal Elevator 11	18
GerMed Periosteal Elevator 13	18
GerMed Periosteal Elevator 14S	18
GerMed Periosteal Elevator 19	18
GerMed Periosteal Elevator 50	18
GerMed Periosteal Elevator 51	18
GerMed Periosteal Elevator 8	18
GerMed Periosteal Elevator 9	18
GerMed Periosteal Elevator 9M	18
GerMed Periosteal Elevator Single Ended 6	19
GerMed Periosteal Elevator Single Ended 7.....	19
GerMed Periostomes Kit	48
GerMed Periotome #1	25
GerMed Periotome #2	25
GerMed Periotome #3	25
GerMed Periotome #4	25
GerMed Periotome #5, Small Gouge	25
GerMed Root Tip Elevator 31G/30G Large Handle	17

GerMed Root Tip Elevator 31G/30G Short Handle	17
Goldman Fox Scissors 5" Curved	29
Goldman Fox Scissors 5" Curved, SuperCut	32
Goldman Fox Scissors 5" Curved, Tungsten Carbide	31
Goldman Fox Scissors 5" Straight	29
Goldman Fox Scissors 5" Straight, Tungsten Carbide	31
Gracey Curette Double Ended, 5/6	8
Gracey Curettes 1/2, Double Ended	9
Gracey Curettes 11/12, Double Ended	9
Gracey Curettes 11/14, Double Ended	9
Gracey Curettes 12/13, Double Ended	9
Gracey Curettes 13/14, Double Ended	9
Gracey Curettes 15/16, Double Ended	9
Gracey Curettes 17/18, Double Ended	9
Gracey Curettes 3/4, Double Ended	9
Gracey Curettes 7/8, Double Ended	9
Gracey Curettes 9/10, Double Ended	9
Gracey Deep Pocket Curette 1/2 Long	9
Gracey Deep Pocket Curette 11/12 Long	9
Gracey Deep Pocket Curette 13/14 Long	9
Gracey Deep Pocket Curette 3/4 Long	9
Gracey Deep Pocket Curette 5/6 Long	9
Gracey Deep Pocket Curette 7/8 Long	9
Gracey Deep Pocket Curette 9/10 Long	9
Graduated Probe, Style "C"	11

H

Halstead Mosquito Forceps 4 3/4" Curved	36
Halstead Mosquito Forceps 4 3/4" Straight	36
Hartman Hemostatic Forceps 3 1/2" Curved	36
Hartman Hemostatic Forceps 3 1/2" Straight	36
Heidbrink Root Tip Pick, Del H1, , Straight, 5 1/4"	6
Heidbrink Root Tip Pick, Del H2-3, Double Ended, 7 3/4"	6
Heidbrink Root Tip Pick, Del H3, Delicate, Left, 5 1/4".....	6
Heidbrink Root Tip Pick, Del H3, Delicate, Right, 5 1/4"	6
Hirschfeld File, 3-7 Tartar Removal File	13
Hirschfeld File, 5-11 Tartar Removal File	13
Hirschfeld File, 9-10 Tartar Removal File	13
Holmstrom Finger Plugger, Removable Handle,Style 50	26
Holmstrom Finger Plugger, Removable Handle,Style 90	26
Holmstrom Finger Plugger, Removable Handle,Style 90	26
Holmstrom Finger Spreader,Removable Handle, 50	26
Holmstrom Modified Elevator 15H	14
Holmstrom Modified Elevator 16H	14
Holmstrom Modified Elevator 5H	14
Holmstrom Plugger, Single Ended, Straight, Style 20	26
Holmstrom Plugger, Single Ended, Straight, Style 35	26

INDEX

Holmstrom Plugger, Single Ended, Straight, Style 50	26
Holmstrom Plugger, Single Ended, Straight, Style 65	26
Holmstrom Plugger, Single Ended, Straight, Style 90	26
Holmstrom Plugger/Spreader 26mm, Style 20	26
Holmstrom Plugger/Spreader 26mm, Style 35	26
Holmstrom Plugger/Spreader 42mm, Style 50	26
Holmstrom Plugger/Spreader 42mm, Style 65	26
Holmstrom Plugger/Spreader 42mm, Style 90	26
Holmstrom Plugger/Spreader Kit	48
Holmstrom Spreader, Single Ended, Straight, Style 20	26
Holmstrom Spreader, Single Ended, Straight, Style 35	26
Holmstrom Spreader, Single Ended, Straight, Style 50	26
Holmstrom Spreader, Single Ended, Straight, Style 65	26
Holmstrom Spreader, Single Ended, Straight, Style 90	26
Howard Bone File #12, Double Ended	13
Howard Bone File #12, Double Ended	13
Howard Bone File #12CA, Double Ended	13
Howard Surgical Elevator 1	15
Hufr Prichard Periosteal Elevator	19

I

Interpromial Scaler 204S, Double Ended	7
Iris Dental Gum Scissors 4 1/2", Angled	29
Iris Dental Gum Scissors 4 1/2", Curved	29
Iris Dental Gum Scissors 4 1/2", Curved, SuperCut	32
Iris Dental Gum Scissors 4 1/2", Curved, Tungsten Carbide	31
Iris Dental Gum Scissors 4 1/2", Straight	29
Iris Dental Gum Scissors 4 1/2", Straight, SuperCut	32
Iris Dental Gum Scissors 4 1/2", Straight, Tungsten Carbide	31
Iris Dental Gum Side Cutting Scissors 4 1/2"	29

J

Jacquette Scaler H 6/7	6
Jacquette Scaler, 20/33	6
Jacquette Scaler, 31/32	6
Jacquette Scaler, 33/H5	6
Jacquette Scaler, 34/35	6
Jacquette Scaler, Double Ended, 1Y/1Y	6
Jacquette Scaler, Double Ended, 2/3	6
Jacquette Scaler, Double Ended, 2S/3S	6
Jacquette Scaler, Double Ended, 2Y/3Y	6
Jacquette Scaler, Single Ended, U-15	6
Jacquette Sickle Scaler H5/J33	6
Joseph Scissors 5 1/2" Curved	30
Joseph Scissors 5 1/2" Straight	30

K

Kelly Dental Gum Scissors 6 1/4", Curved	29
Kelly Dental Gum Scissors 6 1/4", Curved, TC	31
Kelly Dental Gum Scissors 6 1/4", Straight	29
Kelly Dental Gum Scissors 6 1/4", Straight, TC	31
Kelly Hemostatic Forceps 5 1/2" Curved	36
Kelly Hemostatic Forceps 5 1/2" Straight	36
Kilner Tenotomy Scissor 4 1/4" Cur'ved	30
Kilner Tenotomy Scissor 4 1/4" Straight	30
Kirkland 15K/16K Gingectomy Knife	27
Kirkland Tissue Retractors, 1, Dull	42
Kirkland Tissue Retractors, 1, Sharp	42
Kirkland Tissue Retractors, 2, Dull	42
Kirkland Tissue Retractors, 2, Sharp	42
Kirkland Tissue Retractors, 3, Dull	43
Kirkland Tissue Retractors, 3, Sharp	42
Kirkland Tissue Retractors, 4, Dull	43
Kirkland Tissue Retractors, 4, Sharp	42
Kirkland Tissue Retractors, 5, Dull	43
Kirkland Tissue Retractors, 5, Sharp	42
Knife Handle #3	4
Kurtzman Periotome Contra Angled, for Posteriors	25
Kurtzman Periotome Flat Blade/Socket Expander	25

L

LaGrange Scissors 4 1/2" Double Curved	30
LaGrange Scissors 4 1/2" Double Curved, SuperCut	32
LaGrange Scissors 4 1/2" Double Curved, TC	31
Locklin Gum Scissors, Curved, 6 1/4"	29
Locklin Gum Scissors, Straight Shanks, 6 1/4"	29
Lucas Bone Curette, No. 85	10
Lucas Bone Curette, No. 86	10
Lucas Bone Curette, No.87	10
Luxating Elevator 2mm Blade Left	14
Luxating Elevator 2mm Blade Right	14
Luxating Elevator, Back Curved Tip 2mm, 5 3/4"	15
Luxating Elevator, Back Curved Tip 4.5mm, 5 3/4"	15
Luxating Elevator, Back Curved Tip 4mm, 5 3/4"	15
Luxating Elevator, Back Curved Tip 5mm, 5 3/4"	15
Luxating Elevator, Back-Curved Tip 3mm, 5 3/4"	15
Luxating Elevator, Curved 3mm, Fiber Handle	14
Luxating Elevator, Curved 5mm, Fiber Handle	14

INDEX

Luxating Elevator, Curved Tip 2mm, 5 3/4"	14
Luxating Elevator, Curved Tip 2mm, 5 3/4"	14
Luxating Elevator, Curved Tip 3mm, 5 3/4"	14
Luxating Elevator, Curved Tip 4mm, 5 3/4"	14
Luxating Elevator, Curved Tip 5mm, 5 3/4"	14
Luxating Elevator, Inside Bent Tip 3mm 5 3/4"	14
Luxating Elevator, Inside Curved Tip 2mm, 5 3/4"	14
Luxating Elevator, Inside Curved Tip 4.5mm, 5 3/4"	14
Luxating Elevator, Inside Curved Tip 5mm, 5 3/4"	14
Luxating Elevator, Inside-Curved Tip 3mm, 5 3/4"	14
Luxating Elevator, Straight 3mm, Fiber Handle	14
Luxating Elevator, Straight 5mm, Fiber Handle	14
Luxating Elevator, Straight Tip 2mm, 5 3/4"	15
Luxating Elevator, Straight Tip 3mm, 5 3/4"	15
Luxating Elevator, Straight Tip 4.5mm, 5 3/4"	15
Luxating Elevator, Straight Tip 4mm, 5 3/4"	15
Luxating Elevator, Straight Tip 5mm, 5 3/4"	15
Luxating Elevators Set of 6	44

M

Marquette Amalgam Plugger 0/1	27
Mathieu Lichtenberg Needle Holder 5 1/2" Tungsten Carbide	35
Mathieu Lichtenberg Needle Holder 6 1/2" Tungsten Carbide	35
Mathieu Needle Holder 5 1/2" Tungsten Carbide	35
Mathieu Needle Holder 6 1/4" Tungsten Carbide	35
Mathieu Olsen Hegar Needle Holder 5 1/2" TC	35
Mathieu Olsen Hegar Needle Holder 6 3/4" TC	35
Mayo Hegar Needle Holder 5 1/4"	33
Mayo Hegar Needle Holder 6"	33
Mayo Hegar Needle Holder, Serrated, 5", Tungsten Carbide	35
Mayo Hegar Needle Holders, Serrated, 6", Tungsten Carbide	35
McCalls Curette, Style 11/12	9
McCalls Curette, Style 13/14	9
McCalls Curette, Style 13/14, Cut Back, Feline Curette	9
McCalls Curette, Style 13S/14S	9
McCalls Curette, Style 17/18	9
McFarland Bone Chisel #18	5
Metzenbaum Gum Scissors 5 1/2" Curved	30
Metzenbaum Gum Scissors 5 1/2" Straight	30
Micro Friedman Dental Rongeur 5 1/2", Slightly Curved	43
Miller Bone Curette #10	10
Miller Bone Curette #10, Finer, Feline use	10
Miller Bone File #45, Double Ended	13
Miller Bone File #64, Double Ended	13
Miller Periosteal Curette #10	8

Mini Ryder Needle Holder 5", Tungsten Carbide	35
Mini Ryder Needle Holder 6", Tungsten Carbide	35
Mini Ryder Needle Holder 7 1/4", Tungsten Carbide	35
Mini Tightening Ratchet	20
Minnesota Cheek Retractor	3
Minnesota Dental Wax Carver 1	28
Mirror Handle Cone Socket/Mirror #3	28
Mirror Handle Cone Socket/Mirror #4	28
Modified Elevator 100GH	14
Molt 5 Periosteal Elevator, Single Ended	19
Molt 9 Periosteal Elevator, Double Ended M9	18
Molt 9 Periosteal Elevator, D/E M9, Short Handle	18
Morse Scaler 0-00	7
Mouth Gag	3

N

Noyes Micro Angled Scissors 4"	31
Noyes Micro Scissors 4" Curved	31
Noyes Micro Scissors 4" Straight	31

O

Ochsenbein Periodontal Bone Chisel #1	5
Ochsenbein Periodontal Bone Chisel #2	5
Ochsenbein Periodontal Bone Chisel #3	5
Ochsenbein Periodontal Bone Chisel #4	5
Offset Heavy Scaler, Remington 3/4	6
Offset Heavy Scaler, S-129	6
Offset Micro Surgical Scissor 6" Straight	30
Offset Sickle Scaler H6/H7	7
Olsen Hegar Needle Holder 4 3/4" Delicate	33
Olsen Hegar Needle Holder 4 3/4" Delicate, TC	34
Olsen Hegar Needle Holder 5 1/2"	33
Olsen Hegar Needle Holder 5 1/2", Tungsten Carbide	34
Olsen Hegar Needle Holder 6 1/2"	33
Olsen Hegar Needle Holder 6 1/2", Tungsten Carbide	34
Orban 1/2 Gingivectomy Knife	27
Orban Knife 1-2	27

P

Peets Dental Root Extracting Forceps 4 3/4"	41
Periosteal Elevator, Mini Prichard	19
Plastic Filling Dental Instrument 11	25

INDEX

Plastic Filling Dental Instrument A6	25
Plastic Filling Dental Instrument CJZ	25
Plier Type Needle Holders, Tungsten Carbide Insert	34
Plugger, Extra Long, Straight, Size 120, 120mm Long Point	27
Plugger, Extra Long, Straight, Size 140, 120mm Long Point	27
Plugger, Extra Long, Straight, Size 50, 120mm Long Point	27
Plugger, Extra Long, Straight, Size 65, 120mm Long Point	27
Plugger, Extra Long, Straight, Size 90, 120mm Long Point	27
Polokoff Bone File #1, Double Ended	13
Precision Scissor 4 1/2" Slightly Curved	30
Prichard Retractor L/R	42
Probe 20-23 Explorer TT DE	11
Probe/Explorer, Double Ended, 3, 6, 9 & 12mm	11
Probe/Explorer, Double Ended, 3, 6, 9, 12, 15 & 18mm	11
Probe/Explorer, Markings are 1,2,3,5,7,8,9 & 10mm	11

R

Rabbit and Rodent Spatula	28
Rabbit Extraction Kit	48
Rabbit Molar Cutters	31
Rabbit Molar Forceps	36
Removable Handle for Winged Elevator-Handle Only	20
Res Plugger H-1	26
Resorptive Lesion Probe	10
Rodent Wire Mouth Gag, Lightweight	3
Root Elevator 1.3mm 30G, Long Handle	17
Root Elevator 1.3mm 31G, Long Handle	17
Root Elevator 1.3mm 3S, Long Handle	17
Root Elevator 1.3mm Inside Curved Tip	17
Root Elevator 1.3mm Outside Curved Tip	17
Root Elevator 1.3mm Straight Tip	17
Root Elevator, Crane Pick, DEL 34	24
Root Elevator, Crane Pick, DEL 34S	23
Root Elevator, Crane Pick, DEL46	23
Root Elevator, Double Ended #3	17
Root Elevators, Apical, DEL 301	23
Root Elevators, Apical, DEL 302HF	23
Root Elevators, Apical, DEL 303HF	23
Root Elevators, DEL 78	24
Root Tip Elevator #94	17
Root Tip Elevator #95	17
Root Tip Elevator, Del 79, Curved Right, 5 1/2"	24
Root Tip Elevator, Del 80, Curved Left, 5 1/2"	24
Root Tip Extraction Forceps 6"	41
Root Tip Pick, Double Ended	6

S

Scaler Delicate YG-15/Morse 00	7
Schluger 9/10 Furcation File	13
Scraper, Angular Point	4
Scraper, Curved, with Straight Edge	4
Scraper, Curved, With Angle Edge	4
Scraper, Double End, Curved, With Angled Edges	4
Seldin DEL S23 Periosteal Elevator	18
Seldin Surgical Elevator 34S	23
Senn Miller Retractor 3 Prongs Blunt 6 1/4"	41
Senn Miller Retractor 3 Prongs Sharp 6 1/4"	41
Sickle Scaler N-135	7
Sickle Scaler Small, Curved Z-135	7
Sickle Scaler Small, Younger-Good 7/8	7
Sickle/ Hoe Scaler H5/H48	7
Sickle/Hoe Scaler Small YG-15/XS-15	7
Siegel Round Knife Handle #5	4
Slim Dental Curette	8
Spatula #24	28
Specialized Instrument Set	49
Spreader Long, Straight, Size 50, 120mm Long Point	27
Spreader, Long, Straight, Size 120, 120mm Long Point	27
Spreader, Long, Straight, Size 140, 120mm Long Point	27
Spreader, Long, Straight, Size 65, 120mm Long Point	27
Spreader, Long, Straight, Size 90, 120mm Long Point	27
Standard Extracting Forceps #1	39
Stellbrink Rongeur 6 3/4", 2mm Tip, 30 Degree Angle	43
Stellbrink Rongeur 6 3/4", 2mm Tip, 45 Degree Angle	43
Sterilization Tray Holds up 12 Instruments	50
Sterilization Tray , Holds up 16 Instruments	50
Sterilization Tray Holds up 20 Instruments	50
Sterilization Tray, Holds up 5 Instruments	50
Sterilization Tray, Holds up 6 Instruments	50
Sterilizer Winged Elevator Cassette	50
Sterilizer, Needle, Spiral Rack	50
Subgingival Curette	9
Sugarman 1S/2S Furcation File	13
Sugarman 3S/4S Furcation File	13
Surgical Feline Elevator #15	16
Surgical Feline Elevator #16	16
Surgical Feline Elevator #5	16
Surgical Feline Elevator 100G	16
Surgical Feline Periosteal Elevator DEL W2	16
Surgical Root Elevator #100	23
Surgical Root Elevator #100R	23

INDEX

T

Tartar Hoe, Heavy Kirkland 13K/13KL	7
Tartar Remover Forceps 4 3/4"	36
Tartar Scraper 5 3/4" Triangular Tip	4
Tartar Scraper D/E, Curved, Ang, style #12	4
Tartar Scraper, Claw Type	4
Tongue Depressor Retractor	41
Towner-Jacquette Scaler U15-30	6

U

Universal Curette 2R/2L	8
Universal Curette 4R/4L	8
Universal Extracting Forceps 17S	39
Universal Extracting Forceps, 150S	39
Universal Extracting Forceps, 151S	39

V

Vannas After-Cataract Scissors, 3 1/8", Straight	29
Vannas Scissors, Angled on Flat, 3"	29

W

Wakefield Bone Chisel 1W	5
Wakefield Bone Chisel 2W	5
Warwick James Root Elevator, Straight	17
Wedelstaedt Chisel 1/2	5
Wedelstaedt Chisel 3/4	5
Wedelstaedt Chisel 5/6	5
Williams Probe/Explorer, 1,2,3,4,5,6,7,8,9,10,11,12,13,14 & 15mm	11
Williams Probe/Explorer, 1,2,3,5,7,8,9 & 10mm	11
Winged Elevator ,D/E, Ends are 3mm/4mm, Forward	21
Winged Elevator ,D/E, Ends are 3mm/4mm, Inside Bent	21
Winged Elevator ,D/E, Ends are 3mm/4mm, Straight	21
Winged Elevator ,D/E, Ends are 7mm/8mm, Backward Angle	21
Winged Elevator ,D/E, Ends are 7mm/8mm, Forward Angle	21
Winged Elevator ,D/E, Ends are 7mm/8mm, Outside Bent	21
Winged Elevator ,D/E, Ends are 7mm/8mm, Straight	21
Winged Elevator 2mm, Short Handle	20
Winged Elevator 3mm, Short Handle	20
Winged Elevator 4mm, Short Handle	20
Winged Elevator 5mm, Short Handle	20
Winged Elevator 6mm, Short Handle	20
Winged Elevator 7mm, Short Handle	20

Winged Elevator Back-Bent Kit	47
Winged Elevator Back-Bent 1mm	21
Winged Elevator Back-Bent 2mm	21
Winged Elevator Back-Bent 3mm	21
Winged Elevator Back-Bent 4mm	21
Winged Elevator Back-Bent 6mm	21
Winged Elevator Back-Bent 8mm	21
Winged Elevator Back-Bent Kit	47
Winged Elevator Curette Style Kit	47
Winged Elevator Inside-Bent 1mm	21
Winged Elevator Inside-Bent 2mm	21
Winged Elevator Inside-Bent 3mm	21
Winged Elevator Inside-Bent 4mm	21
Winged Elevator Inside-Bent 6mm	21
Winged Elevator Inside-Bent 8mm	21
Winged Elevator Inside-Bent Kit	48
Winged Elevator Long Handle 1.2mm Backward	22
Winged Elevator Long Handle 1.2mm Forward	22
Winged Elevator Long Handle 2mm Backward	22
Winged Elevator Long Handle 2mm Forward	22
Winged Elevator Long Handle 3mm Backward	22
Winged Elevator Long Handle 3mm Forward	22
Winged Elevator Long Handle 4mm Backward	22
Winged Elevator Long Handle 4mm Forward	22
Winged Elevator Long Handle 5mm Backward	22
Winged Elevator Long Handle 5mm Forward	22
Winged Elevator Long Handle 6mm Backward	22
Winged Elevator Long Handle 6mm Forward	22
Winged Elevator Long Handle 7mm Backward	22
Winged Elevator Long Handle 7mm Forward	22
Winged Elevator Long Handle 8mm Backward	22
Winged Elevator Long Handle 8mm Forward	22
Winged Elevator Set- Large 2,3,4,5,6,7 and 8 mm	44
Winged Elevator Short Handle 1.2mm Backward	22
Winged Elevator Short Handle 1.2mm Forward	22
Winged Elevator Short Handle 1.2mm Straight	22
Winged Elevator Short Handle 2mm Backward	22
Winged Elevator Short Handle 2mm Forward	22
Winged Elevator Short Handle 2mm Straight	22
Winged Elevator Short Handle 3mm Backward	22
Winged Elevator Short Handle 3mm Forward	22
Winged Elevator Short Handle 3mm Straight	22
Winged Elevator Short Handle 4mm Backward	22
Winged Elevator Short Handle 4mm Forward	22
Winged Elevator Short Handle 4mm Straight	22
Winged Elevator Short Handle 5mm Backward	22

INDEX

Winged Elevator Short Handle 5mm Forward Angle	2
Winged Elevator Short Handle 5mm Straight	22
Winged Elevator Short Handle 6mm Backward Angle	22
Winged Elevator Short Handle 6mm Forward Angle	2
Winged Elevator Short Handle 6mm Straight	22
Winged Elevator Short Handle 7mm Backward Angle	22
Winged Elevator Short Handle 7mm Forward Angle	2
Winged Elevator Short Handle 7mm Straight	22
Winged Elevator Short Handle 8mm Backward Angle	22
Winged Elevator Short Handle 8mm Forward Angle	2
Winged Elevator Short Handle 8mm Straight	22
Winged Elevator With Removable Handle Set of Four, 2mm, 3mm, 4mm and 5mm	45
Winged Elevator, Double Ended, Ends are 1mm/2mm, Straight	21
Winged Elevator, Double Ended, Ends are 1mm/2mm Inside Bent	21
Winged Elevator, Double Ended, Ends are 1mm/2mm, Back Bent	21
Winged Elevator, Double Ended, Ends are 3mm/3mm Back Bent	21
Winged Elevator, Double Ended, Ends are 3mm/3mm Straight	21
Winged Elevator, Double Ended, Ends are 3mm/4mm, Back Bent	21
Winged Elevator, Double Ended, Ends are 3mm/4mm, Back bent, Backward Angle	21
Winged Elevator, Double Ended, Ends are 3mm/4mm, Inside Bent	21
Winged Elevator, Double Ended, Ends are 3mm/4mm, Outside bent, Backward Angle	21
Winged Elevator, Double Ended, Ends are 3mm/4mm, Straight	21
Winged Elevator, Double Ended, Ends are 5mm/6mm, Backward Angle	21
Winged Elevator, Double Ended, Ends are 5mm/6mm, Inside Bent	21
Winged Elevator, Double Ended, Ends are 5mm/6mm, Straight	21
Winged Elevator, Double Ended, Ends are 7mm/8mm, Backward Angle	21
Winged Elevator, Double Ended, Ends are 3mm/4mm, Straight	21
Winged Elevator, Double Ended, Ends are 7mm/8mm, Inside Bent	21
Winged Elevators 2mm, Long Handle	20
Winged Elevators 3mm, Long Handle	20
Winged Elevators 4mm, Long Handle	20
Winged Elevators 5mm, Long Handle	20
Winged Elevators 6mm, Long Handle	20
Winged Elevators 7mm, Long Handle	20
Winged Elevators 8mm, Long Handle	20
Winged Elevators Set- Small Handle Set of, 1, 2, 2, 3, 4, 6 & 8 mm	45
Winged Tip Elevator with removable handle, 2mm, 4 3/4"	20
Winged Tip Elevator with removable handle, 3mm, 4 3/4"	20
Winged Tip Elevator with removable handle, 4mm, 4 3/4"	20
Winged Tip Elevator with removable handle, 5mm, 4 3/4"	20
Winged Tip Elevator with removable handle, 6mm, 4 3/4"	20
Winged Tip Elevator with removable handle, 7mm, 4 3/4"	20
Winged Tip Elevator with removable handle, 8mm, 4 3/4"	20
Woodson Plastic Filling Dental Instrument W3	25
Woodward Elevator #6	16
Woodward Elevator #7	16